

FAST INSTALL LED MODULE

Meet the needs of various scenarios



FAST INSTALL LED MODULE

5 TYPES FOR FULL SCENARIO APPLICATIONS

1. Reflector Version

2. Lens Version

3. Focus Adjustable Version

4. IP65 Waterproof Version

5. 5CCT Switchable Version

**Seamless connection design.
Matches with various front trims,
performs just like an integrated downlight.**



LED Module — Reflector & Lens Version



Reflector Version



Lens Version



System Output Specifications

Model	Power	Lumen	CCT	BA.	Cutout	Light Source	Driver	IP	CRI
KT7553	15W	1894	3000K	36°	Ø75	Customized COB	KGP	20	90
KT7554	15W	1462	3000K	36°	Ø75	Customized COB	KGP	20	90

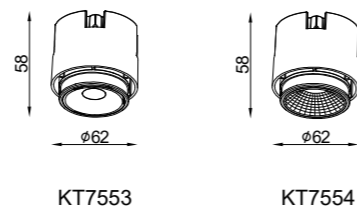

120 lm/W | SDCM < 1

LED Module — Reflector & Lens Version



Highlights

- Efficient Heat Dissipation

Unique textured heat sink for longer service life

- Dual Optics Optional

Both reflector and lens solutions for different needs

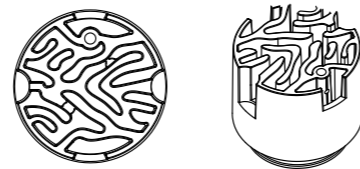

Optical Details

4 Standard Beam Angles,

Custom Angles Available on Request

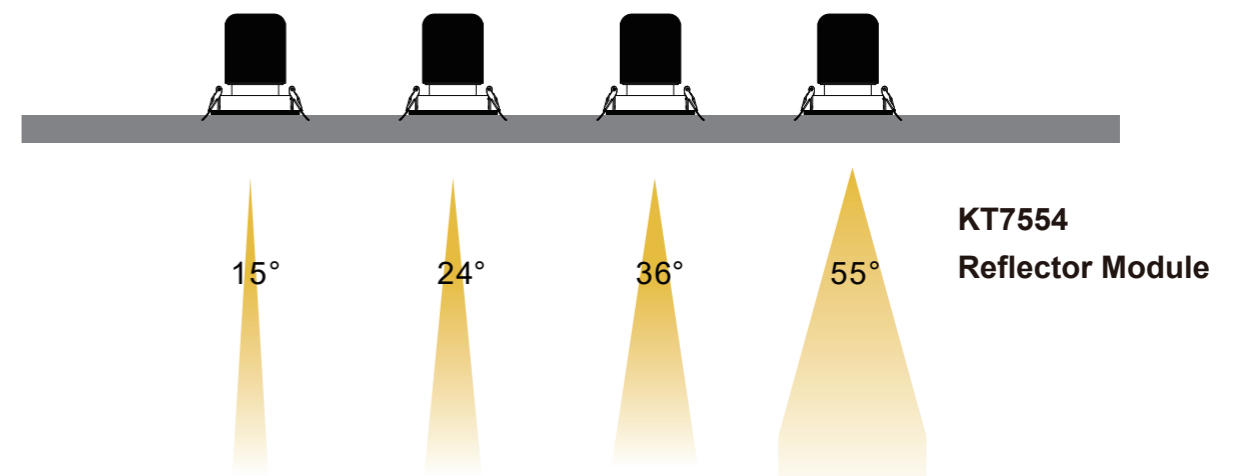
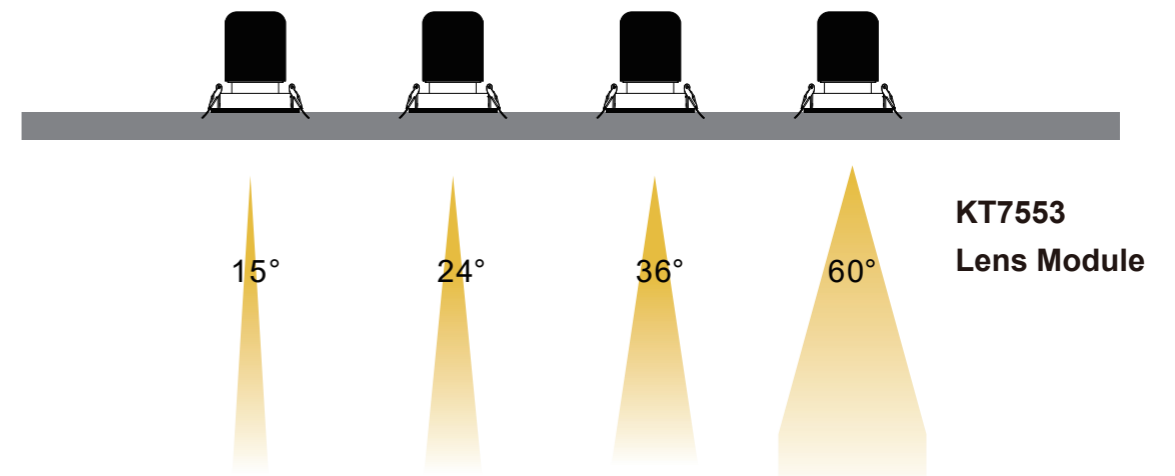

Focus Adjustable Version



15°-36°

15° to 36° Continuous Focus

Freely switch between spot and narrow flood no fixture replacement needed



System Output Specifications

Model	Power	Lumen	CCT	BA.	Cutout	Light Source	Driver	IP	CRI
KT7555	15W	1240	3000K	15°-36°	Ø75	Customized COB	KGP	20	90

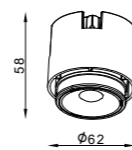

KT7555

LED Module — IP65 Waterproof Version



System Output Specifications

Model	Power	Lumen	CCT	BA.	Cutout	Light Source	Driver	IP	CRI
KT7556	8W	890	4000K	36°	Ø75	Customized COB	KGP	65	90

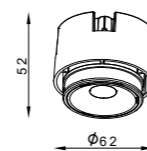

KT7556



IP65 Rated LED Module

Full IP65 dust & water protection
Reliable performance in humid and
dusty environments

LED Module — 5CCT Switchable Version

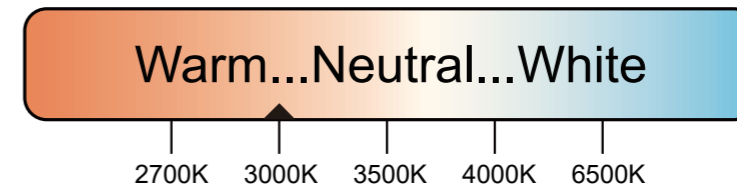
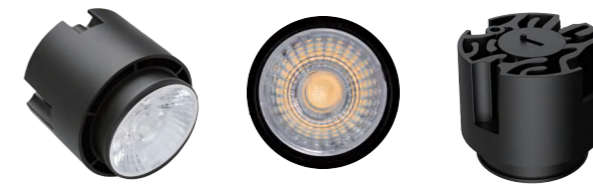
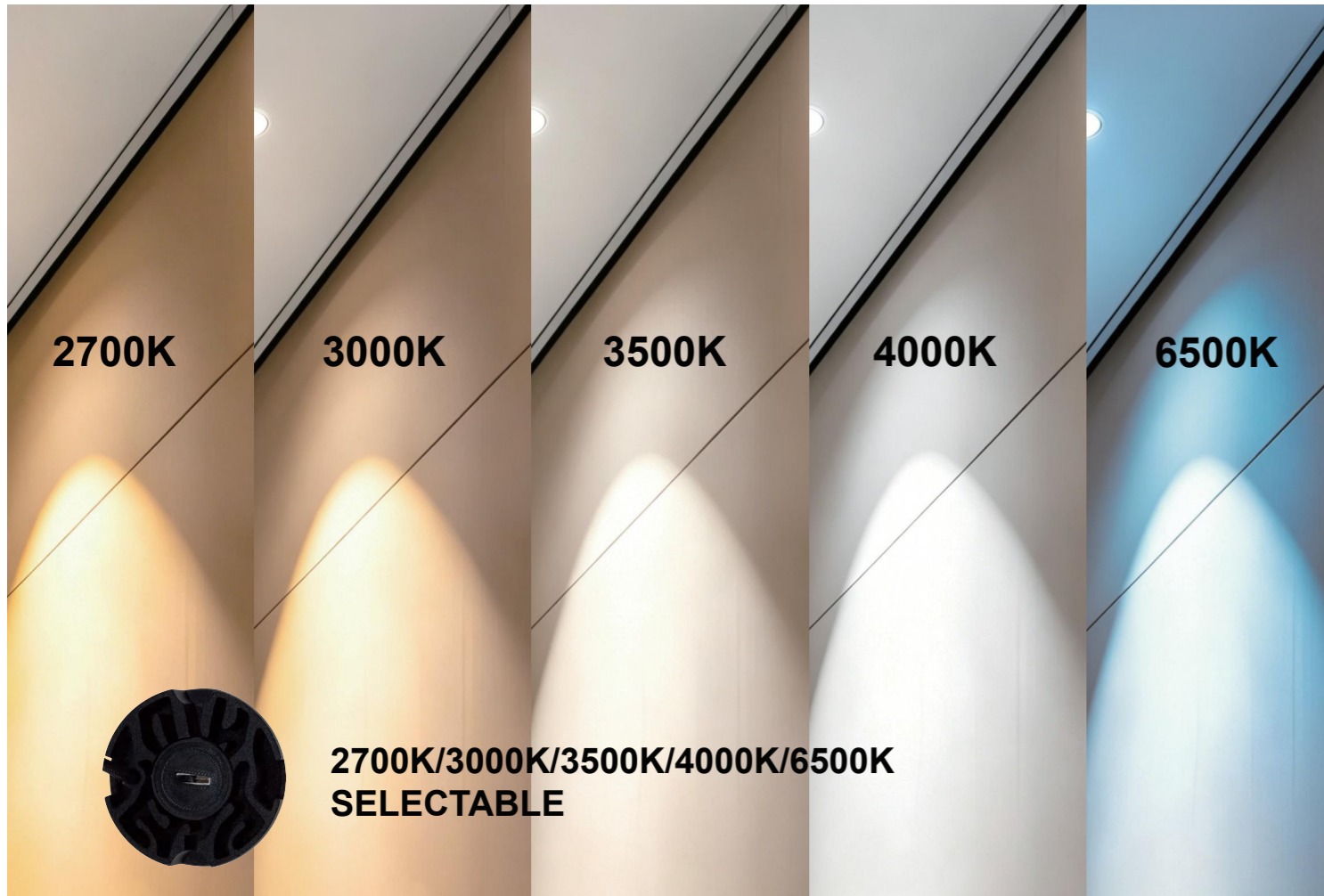

5 CCT Freely Switchable

5 CCT Switchable for Multi-Scenes



System Output Specifications

Model	Power	Lumen	CCT	BA.	Cutout	Light Source	Driver	IP	CRI
KT7557	15W	655	2700K	36°	Φ75	Customized COB	KGP	20	90
KT7557	15W	708	3000K	36°	Φ75	Customized COB	KGP	20	90
KT7557	15W	786	3500K	36°	Φ75	Customized COB	KGP	20	90
KT7557	15W	850	4000K	36°	Φ75	Customized COB	KGP	20	90
KT7557	15W	1034	6500K	36°	Φ75	Customized COB	KGP	20	90

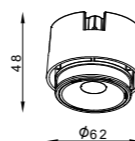

KT7557



Multiple trim options to match different installation needs

Series 1

Series 3

Series 2

Series 4 - Australian market

Multiple trim options for
curved and irregular
ceilings



Series 1

**Various trims for diverse interior
design styles**

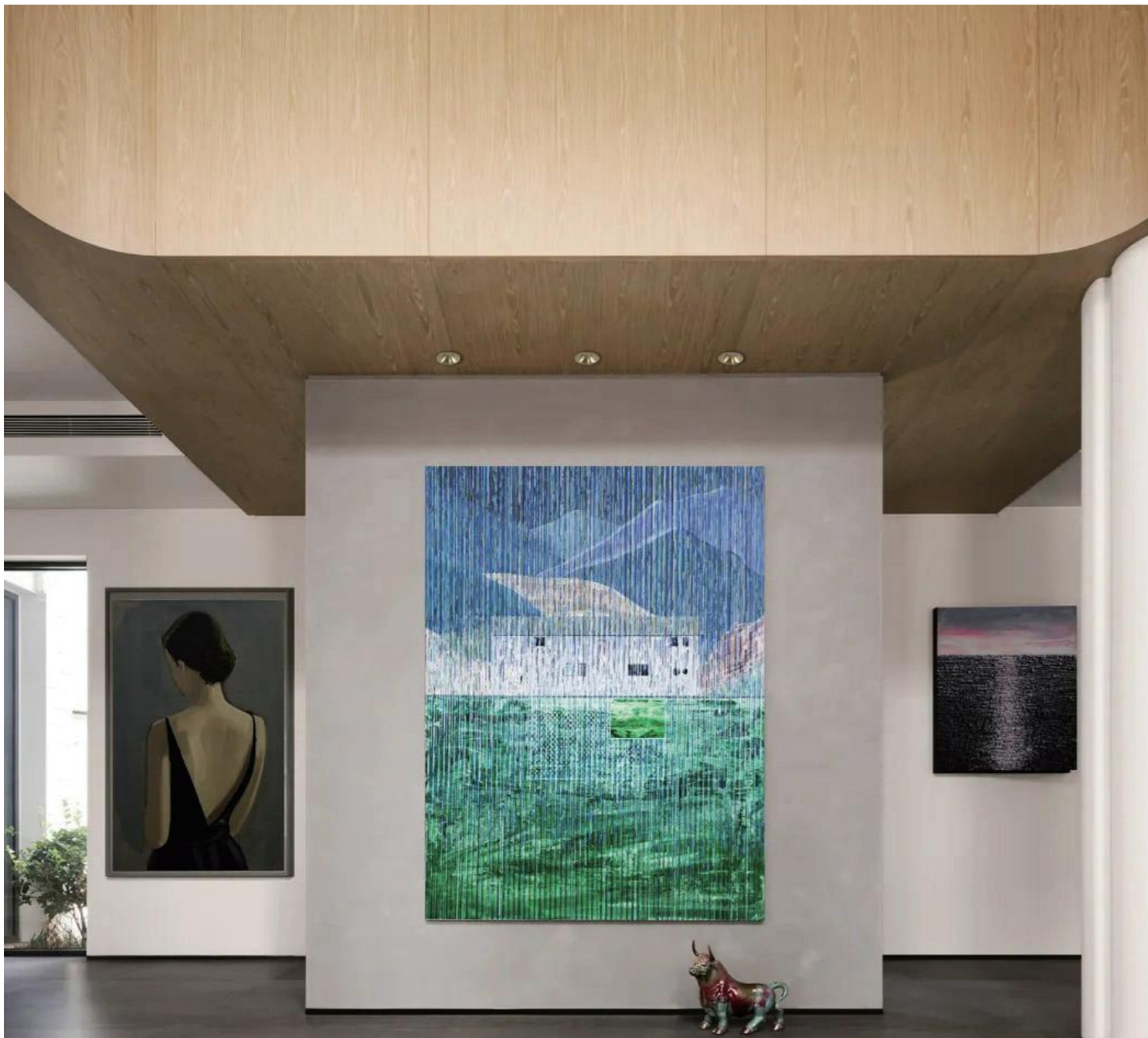

Compatible with GU10 bulb trims
No re-cutting needed for retrofit projects



KT7514



Series 1

**Premium finish options for high-
end commercial & residential projects**

Wall Washer LED Module

Superior Brightness & Precision

1.5x Brighter, 30% More Efficient than standard downlights



Optimized light distribution:
60% wall light + 40% side light



WHY CHOOSE US?



Standard downlight:

75% wall light + 25% side light



Series 1 Mirror Lamp LED Module

Mirror Lamp Module
Anti-glare Soft Light

Series 1

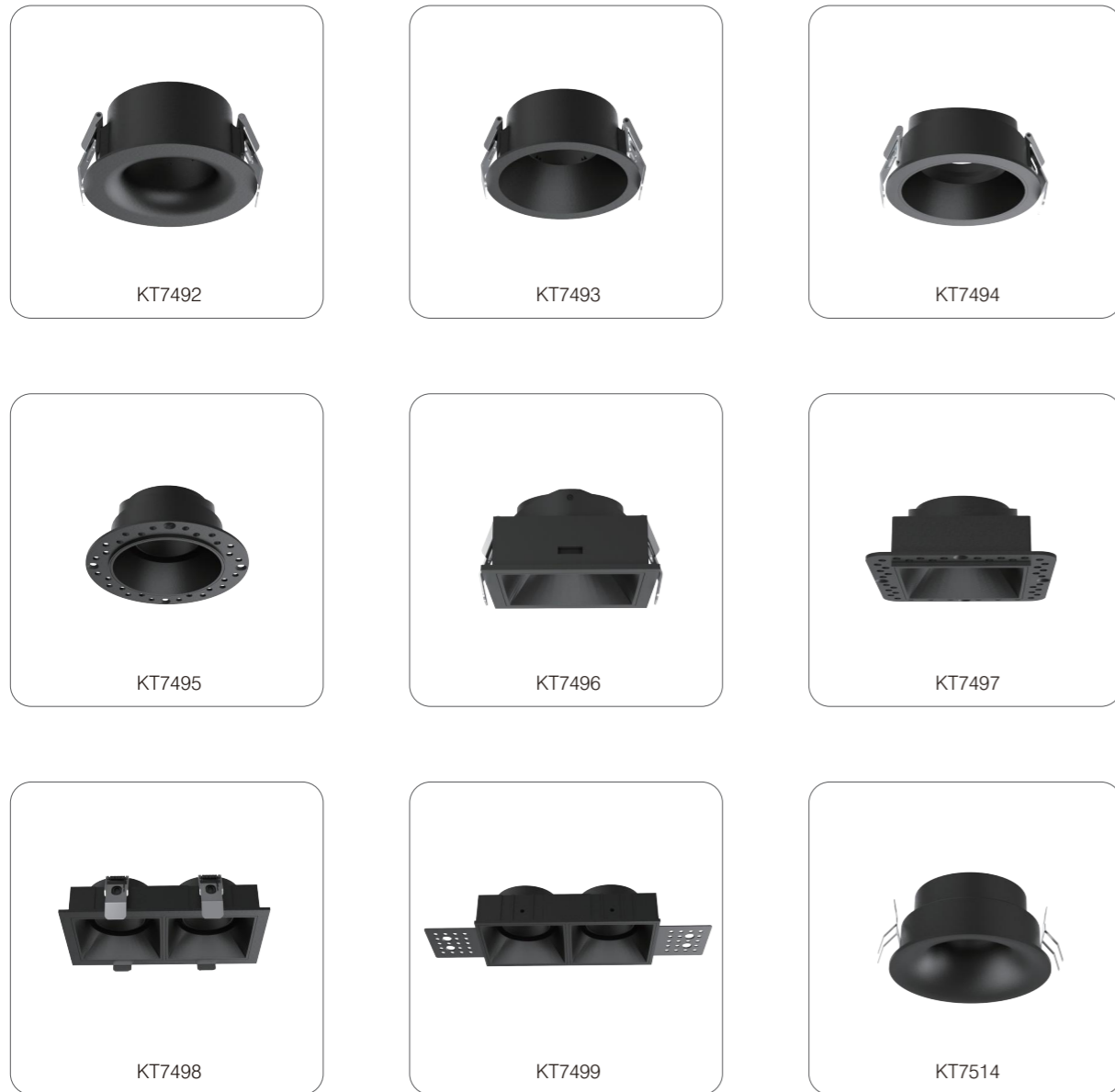

Series 1



Beam angle

KT7516 KT7517

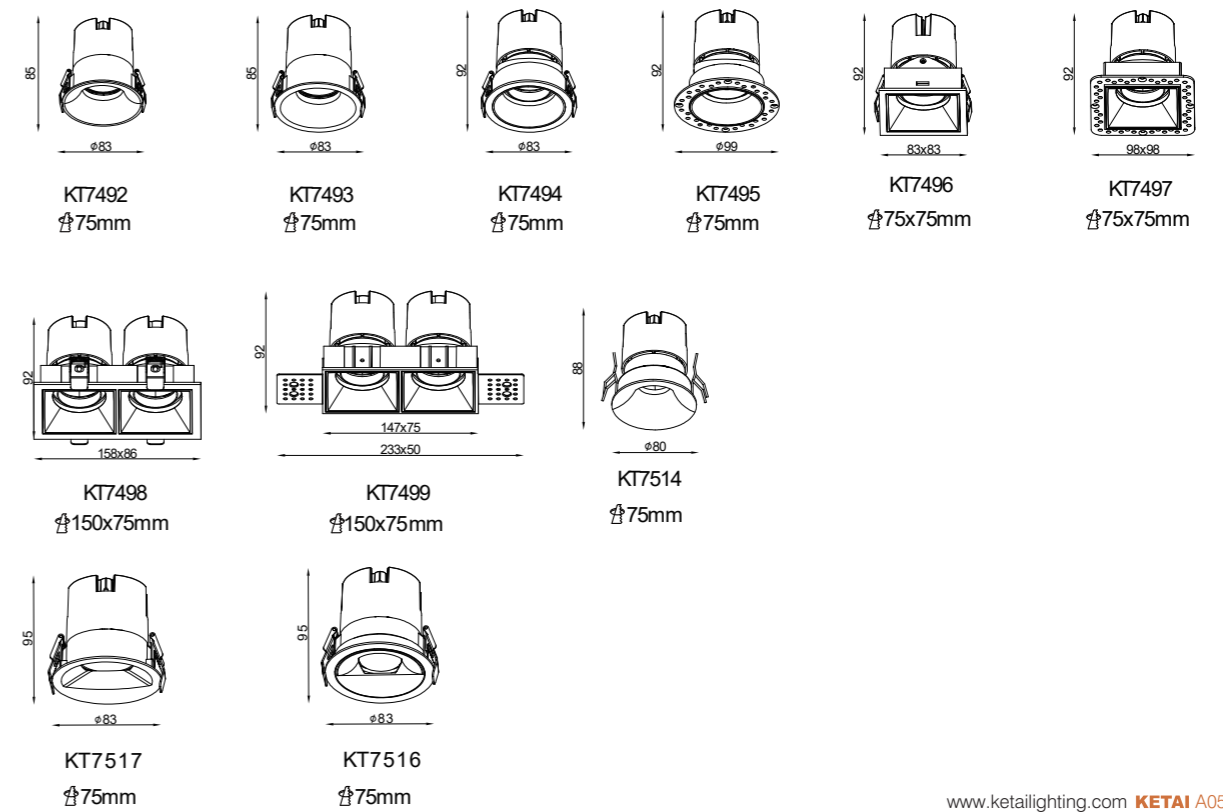

Series 2



MR16 Standard Size
Fast-Install Recessed Module
Retrofit Compatible

Series 2

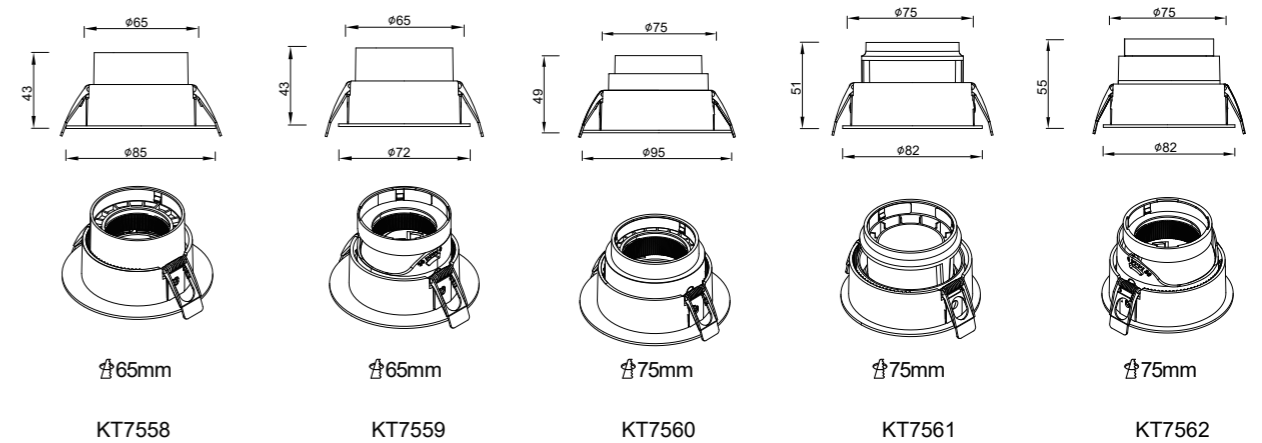

Series 3



Multi-Front Ring Options Round / Square / Single / Twin

Series 3



Series 4 - Australian market



SAA compliant

Engineered for local projects

Fast-install recessed module

Series 4 - Australian market





Warm...Neutral...White

2700K 3000K 3500K 4000K 5000K



North America Market Downlight



2700K

3000K

3500K

4000K

5000K

Power Switchable & CCT Switchable

Spectrum

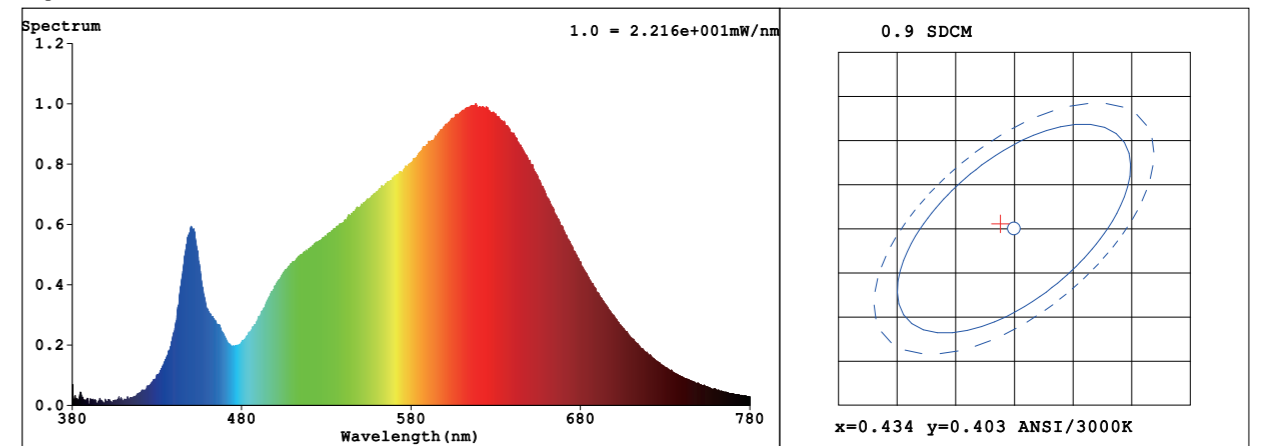

Spectral Distribution

CIE1931 Chromaticity Diagram

120 lm/W High Efficacy

SDCM < 1 | Glareless Module

Available in Lens & Reflector Versions