

**MAGNETIC TRACK
SYSTEM**

**MAGNETIC TRACK
SYSTEM**

SPOT LIGHT
PENDANT LIGHT
LINEAR LIGHT

KETA

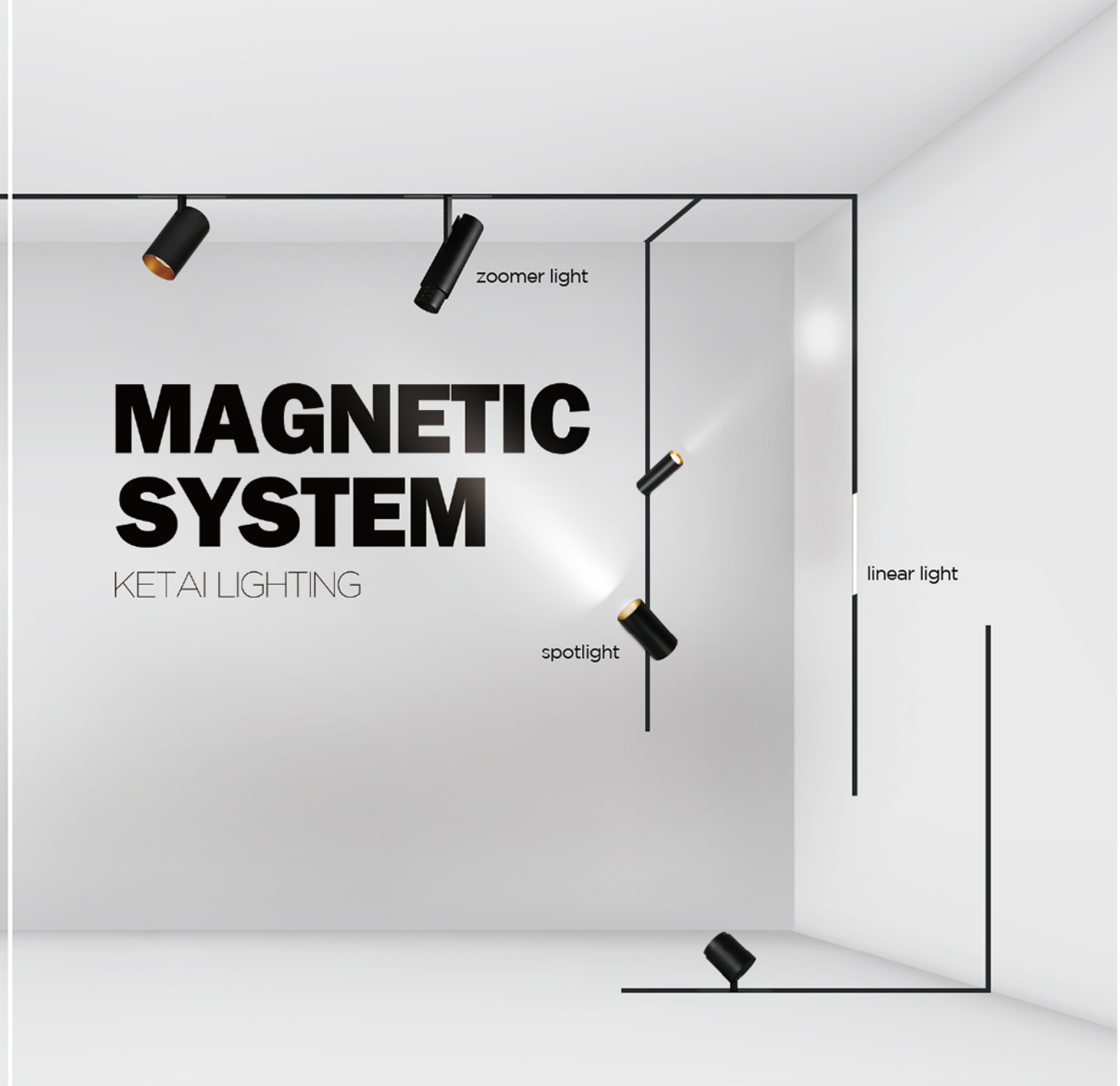

Magnets make life simple

At present, the gradual miniaturization of luminaire has become a trend. People have stricter requirements on the controllability of lighting.

In addition, the need for the installation convenience of the track and the gradual modularization of the luminaire has led to the emergence of low-voltage magnetic tracks.

It provides a reliable and flexible connection system for commercial and residential lighting design, and change the hard-mounted luminaire to soft, to save installation and maintenance costs.



One second installation

Anywhere in the track, various products can be placed, such as spotlight, linear light and pendant light.



Wireless Control

Control your lighting from anywhere. Ketai's wireless lighting system is ultra-efficient and you can control it from anywhere, anytime using your smartphone or tablet.

1 SPOT LIGHT



MHTA8834 / MHTA8835
P1

MHTA8841 / MHTA8841A
MHTA8841B P3

MHTA8851
P5



MHTA8852
P7

MHTA8859
P9

MHTA8890
P11



MHTA8891
P11

MHTA8892
P11

MHTA8893
P11

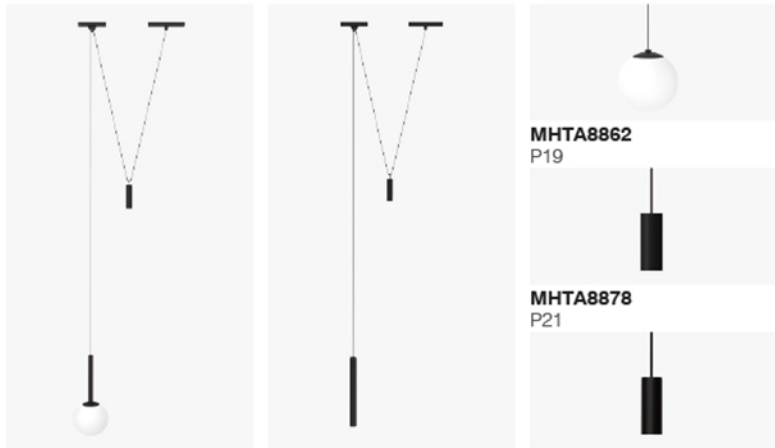

MHTA8926
P25

MHTA8927
P27

MHTA8862
P19

MHTA8878
P21

MHTA8879
P23



19 PENDANT LIGHT



13 ZOOMER LIGHT



MHTA8837
P13



MHTA8863
P15



MHTA8864
P15



MHTA8865
P17



MHTA8866
P17

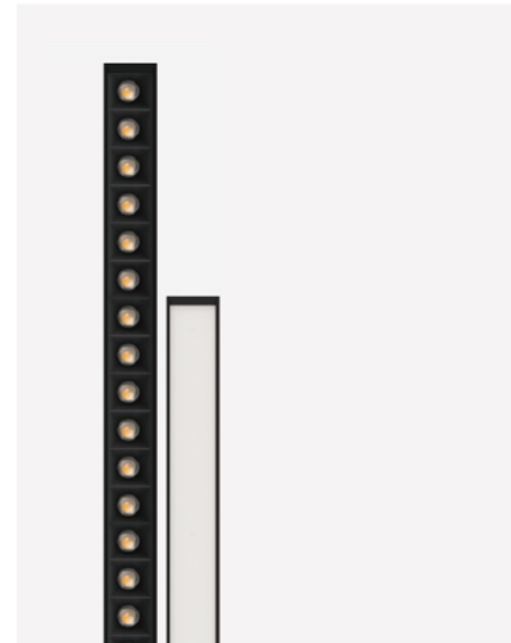

27 LINEAR LIGHT



MHTA8871 / MHTA8871A
P29



MHTA8873 / MHTA8873A
P31

Index

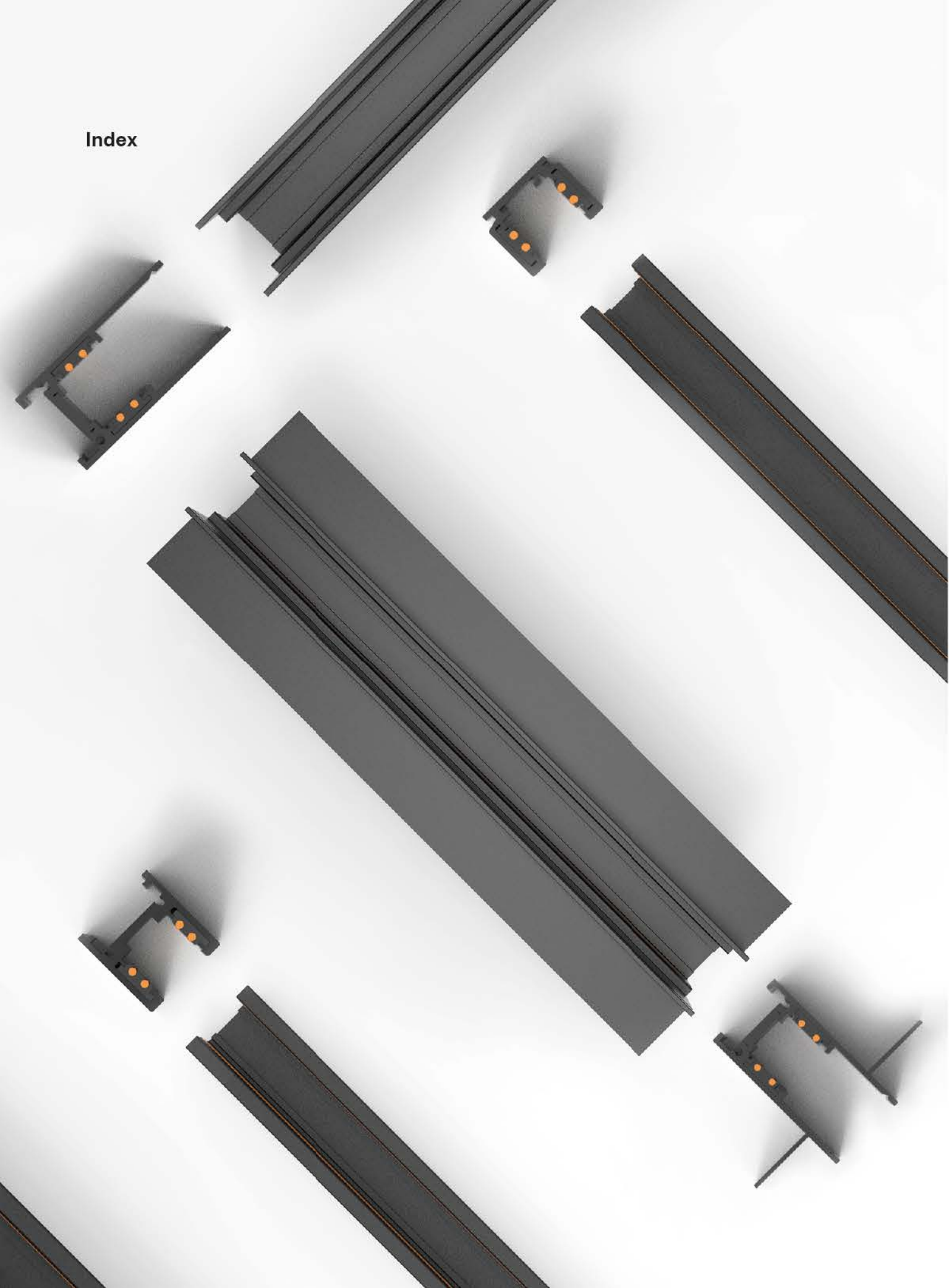

Index

31

MAGNETIC TRACK



MHTA1
P35



MHTA6
P39



MHTA2
P37



MHTA4
P41



SPOT LIGHT



Quickinfo

MHTA8834 @ 3000K, ≥80
10W, 30°, 554LM

MHTA8835 @ 3000K, ≥80
15W, 30°, 942LM

Order options

Color temperature

2700K

3000K

4000K

Color rendering Index

≥80

≥90

Beam angle

MHTA8834- 10° , 30°

MHTA8835- 10° , 30°

Control

Non dim

DALI

PNW DIM

WIRELESS

Installation

Track

Track spot light

Symmetrical light distribution

Protection class IP 20

3 years' availability guarantee

This magnetic track light series is suitable for general basic lighting. The lamp shape can be round or square and the design is ultra-thin with 4 spotlights on the luminous surface. It is beneficial to higher uniformity and wider illumination range.

The design of the luminaires may get upgraded and the specifications of them may be adjusted by different degree. Please visit our website and check the detail description and specification of the luminaires.

LED  DC 48 V IP20 **Bridglux** MHTA8834 **CITIZEN** MHTA8835 **HEP**

	W	LUM	CCT	BEAM	CRI	Dia	T	H
MHTA8834	10	554	3000K	30°	80	Φ90	30	135
MHTA8835	15	942	3000K	30°	80	Φ105	32	153

Light distribution

3000K CRI≥80

MHTA8834 Medium 30°

h (m)	E0° (lx)	Φ (m)
1	869.5	0.62
2	217.4	1.23
3	96.6	1.85
4	54.4	2.47
5	34.8	3.08

MHTA8835 Medium 30°

h (m)	E0° (lx)	Φ (m)
1	1968	0.52
2	492.0	1.03
3	218.6	1.55
4	123.0	2.07
5	78.7	2.58

Finish color

For MHTA8834 / MHT8835

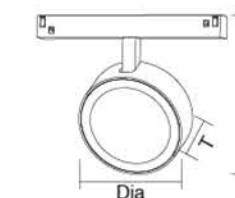



Quickinfo

MHTA8841 @ 3000K, ≥80
8W, 6°, 441LM

MHTA8841A @ 3000K, ≥80
15W, 25°, 897LM

MHTA8841B @ 3000K, ≥80
15W, 25°, 897LM

Order options

Color temperature
2700K
3000K
4000K

Color rendering Index
≥80
≥90

Beam angle
MHTA8841-6°
MHTA8841A-25°
MHTA8841B-25°

Control
Non dim
DALI
PNW DIM
WIRELESS

Installation
Track

SPOT LIGHT



Track spot light

Symmetrical light distribution

Protection class IP 20
3 years' availability guarantee

To meet the different demands for users, we provide lens and reflector versions with different beam angles for selection. The most feature is the narrow beam angle in 6°, the light distribution is uniform, you can illuminate your artwork, pictures and the collection.

The design of the luminaires may get upgraded and the specifications of them may be adjusted by different degree. Please visit our website and check the detail description and specification of the luminaires.

LED  DC 48 V IP20 CREE MHTA8841 Bridgelux HEP

	W	LUM	CCT	BEAM	CRI	DIA	H1	H2
MHTA8841	8	441	3000K	6°	80	Ø60	78	113.2
MHTA8841A	15	897	3000K	25°	80	Ø60	140	175.2
MHTA8841B	15	897	3000K	25°	80	Ø60	140	175.2

Light distribution

3000K CRI≥80

MHTA8841 (LENS) Narrow 6°

h (m)	E0° (lx)	Φ (m)
1	14920	0.10
2	3730	0.20
3	1658	0.30
4	932.5	0.40
5	569.8	0.50

MHTA8841A (REFLECTOR) Medium 25°

h (m)	E0° (lx)	Φ (m)
1	2437	0.41
2	609.3	0.82
3	270.8	1.23
4	152.3	1.64
5	97.5	2.04

MHTA8841B (LENS) Medium 25°

h (m)	E0° (lx)	Φ (m)
1	2437	0.41
2	609.3	0.82
3	270.8	1.23
4	152.3	1.64
5	97.5	2.04

Finish color

For MHTA8841 / MHTA8841A / MHTA8841B

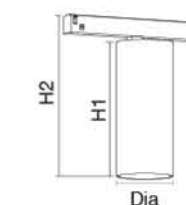
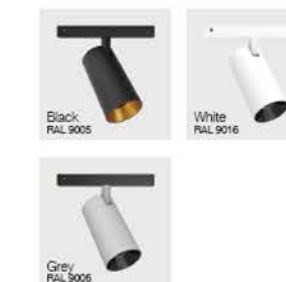



SPOT LIGHT



Light distribution

3000K CRI \geq 80

MHTA8851 Medium 30°

h (m)	E0° (lx)	Φ (m)
1	826.7	0.51
2	206.7	1.02
3	91.9	1.54
4	51.7	2.05
5	33.1	2.56

Finish color

For MHTA8851



Track spot light

Symmetrical light distribution

Protection class IP 20

3 years' availability guarantee

It's an easy-to-install magnetic track spot light. She was born for your focus lighting demands. Exquisite coating, slim shape, elegant looking, makes her outstanding in the same kind of products.

The design of the luminaires may get upgraded and the specifications of them may be adjusted by different degree. Please visit our website and check the detail description and specification of the luminaires.

LED  DC 48 V IP20 Bridgelux HEP

	W	LUM	CCT	BEAM	CRI	Dia	H1	H2
MHTA8851	8	450	3000K	30°	80	Φ40	170.5	105

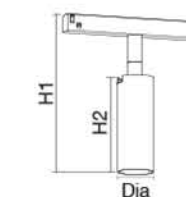

Quickinfo

MHTA8851 @ 3000K, \geq 80
8W, 30°, 282LM

Order options

Color temperature

2700K

3000K

4000K

Color rendering Index

\geq 80

\geq 90

Beam angle

MHTA8851-30°

Control

Non dim

DALI

PNW DIM

WIRELESS

Installation

Track



SPOT LIGHT



Quickinfo

MHTA8852 @ 3000K, ≥80
8W, 30°, 274LM

Order options

Color temperature
2700K
3000K
4000K

Color rendering Index
≥80
≥90

Beam angle
MHTA8852-30°

Control
Non dim
DALI
PNW DIM
WIRELESS

Installation
Track

Track spot light

Symmetrical light distribution

Protection class IP 20
3 years' availability guarantee

He was born for your focus lighting demands. Exquisite coating, square column shape, sharp-looking, make him outstanding in the same kind of products.

The design of the luminaires may get upgraded and the specifications of them may be adjusted by different degree. Please visit our website and check the detail description and specification of the luminaires.

Light distribution

3000K CRI≥80

MHTA8852 Medium 30°

h (m)	E0° (lx)	Φ (m)
1	803.7	0.52
2	200.9	1.04
3	89.3	1.56
4	50.2	2.09
5	32.2	2.61

Finish color

For MHTA8851

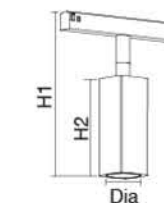

LED DC 48 V IP20 Bridgelux HEP

	W	LUM	CCT	BEAM	CRI	Dia	H1	H2
MHTA8852	8	450	3000K	30°	80	Φ42	170.5	105



SPOT LIGHT



Quickinfo

MHTA8859 @ 3000K, ≥80
9W, 340°, 294LM

Order options

Color temperature

2700K

3000K

4000K

Color rendering Index

≥80

≥90

Beam angle

MHTA8859-340°

Control

Non dim

DALI

PNW DIM

WIRELESS

Installation

Track

Track spot light

Symmetrical light distribution

Protection class IP 20

3 years' availability guarantee

This is an easy-to-install magnetic track globe LED light. Not only suitable for commercial but also residence usage. A moon-like glass ball hanging on your ceiling, the soft lighting shining from up to bottom, how comfortable and warm your room would be.

The design of the luminaires may get upgraded and the specifications of them may be adjusted by different degree. Please visit our website and check the detail description and specification of the luminaires.

LED  DC 48 V IP20 CREE HEP

	W	LUM	CCT	BEAM	CRI	Dia	H1
MHTA8859	9	294	3000K	340°	80	Φ150	166

Light distribution

3000K CRI≥80

MHTA8859 Flat 340°

h (m)	E0° (lx)	Φ (m)
1	28.4	2.00
2	7.1	4.00
3	3.2	6.00
4	1.8	8.00
5	1.1	10.00

Finish color

For MHTA8859

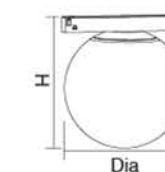



Quickinfo

MHTA8890 @ 3000K, ≥80
30W, 36°, 2651LM

MHTA8891 @ 3000K, ≥80
20W, 36°, 1721LM

MHTA8892 @ 3000K, ≥80
12W, 36°, 1129LM

MHTA8893 @ 3000K, ≥80
8W, 36°, 798LM

Order options

Color temperature

2700K

3000K

4000K

Color rendering Index

≥80

≥90

Beam angle

MHTA8890-36°

MHTA8891-36°

MHTA8892-36°

MHTA8893-36°

Control

Non dim

DALI

PNW DIM

WIRELESS

Installation

Track



Track spot light

Symmetrical light distribution

Protection class IP 20

3 years' availability guarantee

This magnetic track light series is suitable for accent lighting. Product serialization with multiple beam angles can be selected on-demand. The compact design is almost integrated with the track system. It can make up for the shortcomings of directional illumination from the direct lighting products.

The design of the luminaires may get upgraded and the specifications of them may be adjusted by different degree. Please visit our website and check the detail description and specification of the luminaires.

Finish color

For MHTA8890 / MHTA8891 / MHTA8892 / MHTA8893



SPOT LIGHT

Light distribution

3000K CRI≥80

MHT8890 Wide 36°

h (m)	E0° (lx)	Φ (m)
1	6940	0.60
2	1735	1.20
3	771.1	1.79
4	433.8	2.39
5	277.6	2.99

MHT8891 Wide 36°

h (m)	E0° (lx)	Φ (m)
1	3863	0.65
2	965.8	1.30
3	429.3	1.95
4	241.5	2.60
5	154.5	3.24

MHT8892 Wide 36°

h (m)	E0° (lx)	Φ (m)
1	1988	0.77
2	496.9	1.57
3	220.9	2.36
4	124.2	3.14
5	79.5	3.93

MHT8893 Wide 36°

h (m)	E0° (lx)	Φ (m)
1	1907	0.62
2	476.8	1.24
3	211.9	1.87
4	119.2	2.49
5	76.3	3.11

LED DC 48 V IP20 Bridgelux HEP

	W	LUM	CCT	BEAM	CRI	Dia	H1	H2
MHTA8890	30	2651	3000K	36°	80	Φ85	98	150
MHTA8891	20	1721	3000K	36°	80	Φ78	73	135
MHTA8892	12	1129	3000K	36°	80	Φ60	67	122
MHTA8893	8	798	3000K	36°	80	Φ45	66	124

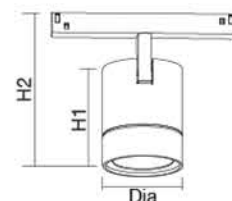



SPOT LIGHT



Quickinfo

MHTA8837 @ 3000K, ≥80
 15W, ZOOM-[10-50°], 277-665LM

Order options

Color temperature
 2700K
 3000K
 4000K

Color rendering Index
 ≥80
 ≥90

Beam angle
 MHTA8837- ZOOM-[10° - 50°]

Control
 Non dim
 DALI
 PNW DIM
 WIRELESS

Installation
 Track

Zoom Track spot light
 Symmetrical light distribution
 Protection class IP 20
 3 years' availability guarantee

The ZOOMER magnetic track spot is more understanding of your angle, rotating and zooming freely. 10-50°, high CRI, to achieve the true sense of freely zoom. One lamp with versatility, space decoration to give more highlights.

The design of the luminaires may get upgraded and the specifications of them may be adjusted by different degree. Please visit our website and check the detail description and specification of the luminaires.

Light distribution
 3000K CRI≥80

MHTA8837		Narrow 10°	
h (m)	E0° (lx)	Φ (m)	
1	10515.0	0.16	
2	2627.0	0.32	
3	1168.0	0.48	
4	657.2	0.64	
5	420.6	0.80	

MHTA8837		Flat 50°	
h (m)	E0° (lx)	Φ (m)	
1	1132	0.88	
2	283.0	1.77	
3	125.8	2.65	
4	70.8	3.54	
5	45.3	4.42	

Finish color
 For MHTA8837

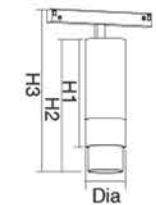

LED DC 48 V IP20 Bridgelux HEP

	W	LUM	CCT	BEAM	CRI	Dia	H1	H2	H3
MHTA8837	15	277-665	3000K	10-50°	80	Φ60	160	194.5	240

ZOOMER LIGHT



Quickinfo

MHTA8863 @ 3000K, ≥80
5W, ZOOM-[17-36°], 84-142LM

MHTA8864 @ 3000K, ≥80
10W, ZOOM-[17-36°], 164-269LM

Order options

Color temperature

2700K

3000K

4000K

Color rendering Index

≥80

≥90

Beam angle

MHTA8863-ZOOM-[17-36°]

MHTA8864-ZOOM-[17-36°]

Control

Non dim

DALI

PNW DIM

WIRELESS

Installation

Track

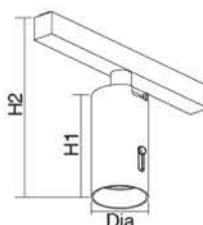

Zoom Track spot light

Symmetrical light distribution

Protection class IP 20

3 years' availability guarantee

This is a family of zoomer LED spot light with different sizes in height. With a knob on the lamp body to adjust the beam angle, from the need of high-lighting a collection to illuminate a large space, you can manage it easily.

The design of the luminaires may get upgraded and the specifications of them may be adjusted by different degree. Please visit our website and check the detail description and specification of the luminaires.

Finish color

For MHTA8863 / MHTA8864



Light distribution

3000K CRI≥80

MHTA8863 Medium 17°

h (m)	E0° (lx)	Φ (m)
1	1170	0.31
2	292.4	0.62
3	130.0	0.92
4	73.1	1.23
5	46.8	1.54

MHTA8863 Wide 36°

h (m)	E0° (lx)	Φ (m)
1	538.1	0.65
2	134.5	1.30
3	60.0	1.95
4	33.6	2.61
5	21.5	3.26

MHTA8864 Medium 17°

h (m)	E0° (lx)	Φ (m)
1	1662	0.32
2	415.5	0.64
3	184.7	0.96
4	103.9	1.27
5	66.5	1.59

MHTA8864 Wide 36°

h (m)	E0° (lx)	Φ (m)
1	981.7	0.60
2	245.4	1.20
3	109.1	1.80
4	61.4	2.40
5	39.3	3.00

LED DC 48 V IP20 Bridgelux HEP

	W	LUM	CCT	BEAM	CRI	Dia	H1	H2
MHTA8863	5	85-142	3000K	17-36°	80	Φ40	78	113.2
MHTA8864	10	164-269	3000K	17-36°	80	Φ40	140	175.2



Quickinfo

MHTA8865 @ 3000K, ≥80
5W, ZOOM-[17-36°], 109-136LM

MHTA8866 @ 3000K, ≥80
10W, ZOOM-[17-36°], 167-269LM

Order options

Color temperature

2700K

3000K

4000K

Color rendering Index

≥80

≥90

Beam angle

MHTA8865-ZOOM-[17-36°]

MHTA8866-ZOOM-[17-36°]

Control

Non dim

DALI

PNW DIM

WIRELESS

Installation

Track

LED  DC 48 V IP20 Bridgelux HEP

	W	LUM	CCT	BEAM	CRI	D1xD2	H1	H2
MHTA8865	5	109-136	3000K	17-36°	80	42x42	78	113.2
MHTA8866	10	167-269	3000K	17-36°	80	42x42	140	175.2

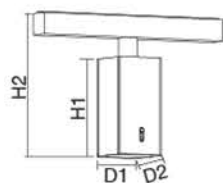

ZOOMER LIGHT

Light distribution

3000K CRI≥80

MHTA8865 Medium 17°

h (m)	E0° (lx)	Φ (m)
1	907.1	0.26
2	226.8	0.52
3	100.8	0.78
4	56.7	1.04
5	36.3	1.30

MHTA8865 Wide 36°

h (m)	E0° (lx)	Φ (m)
1	448.9	0.55
2	112.2	1.11
3	49.9	1.66
4	28.1	2.22
5	18.0	2.77

MHTA8866 Medium 17°

h (m)	E0° (lx)	Φ (m)
1	1303	0.30
2	325.7	0.59
3	144.8	0.89
4	81.4	1.19
5	52.1	1.49

MHTA8866 Wide 36°

h (m)	E0° (lx)	Φ (m)
1	645.1	0.62
2	161.3	1.25
3	71.7	1.87
4	40.3	2.50
5	25.8	3.12

Zoom Track spot light

Symmetrical light distribution

Protection class IP 20

3 years' availability guarantee

ZOOMER magnetic track spot light with two powers. One light for multiple application scenarios makes it popular in the market and reduces the retailers' inventory pressure as well.

The design of the luminaires may get upgraded and the specifications of them may be adjusted by different degree. Please visit our website and check the detail description and specification of the luminaires.

Finish color

For MHTA8865 / MHTA8866





Quickinfo

MHTA8862 @ 3000K, ≥80
9W, 340°, 294LM

Order options

Color temperature

2700K

3000K

4000K

Color rendering Index

≥80

≥90

Beam angle

MHTA8862-340°

Control

Non dim

DALI

PNW DIM

WIRELESS

Installation

Track

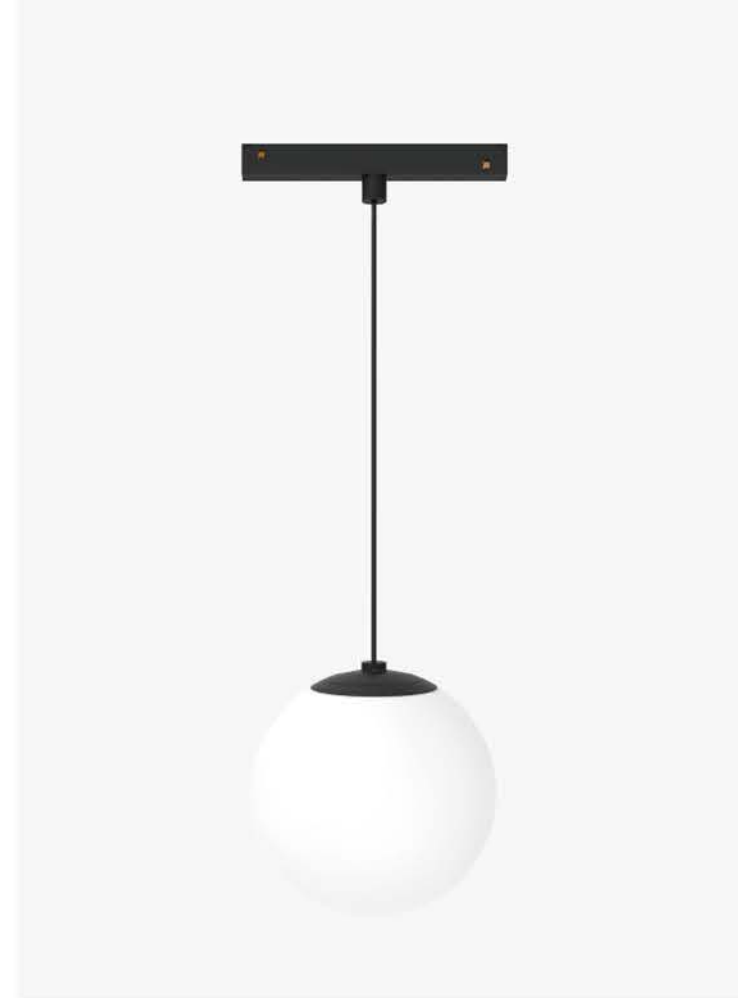

Globe track light

Unshielded light distribution

Protection class IP 20

3 years' availability guarantee

This is an easy-to-install magnetic track globe LED light. Not only suitable for commercial but also residence usage. A moon-like glass ball hanging on your ceiling, the soft lighting shining from up to bottom, how comfortable and warm your room would be.

The design of the luminaires may get upgraded and the specifications of them may be adjusted by different degree. Please visit our website and check the detail description and specification of the luminaires.

LED  DC 48 V IP20 CREE HEP

	W	LUM	CCT	BEAM	CRI	Dia	H
MHTA8862	9	294	3000K	340°	80	Φ150	1400

PENDANT LIGHT

Light distribution

3000K CRI≥80

MHTA8862	Flat 340°		
h (m)	E0° (lx)	Φ (m)	
1	28.4	2.00	
2	7.1	4.00	
3	3.2	6.00	
4	1.8	8.00	
5	1.1	10.00	

Finish color

For MHTA8862

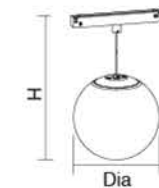



Quickinfo

MHTA8878 @ 3000K, ≥80
8W, 20°, 344LM

Order options

Color temperature

2700K

3000K

4000K

Color rendering Index

≥80

≥90

Beam angle

MHTA8878-20°

Control

Non dim

DALI

PNW DIM

WIRELESS

Installation

Track



PENDANT LIGHT

Light distribution

3000K CRI≥80

MHTA8878 Spot 20°

h (m)	E0° (lx)	Φ (m)
1	1709	0.35
2	427.2	0.71
3	190.0	1.06
4	106.8	1.41
5	68.4	1.77

Finish color

For MHTA8878



Pendant track light

Shielded light distribution

Protection class IP 20

3 years' availability guarantee

The square design is simple and integrated with the magnetic track system and application environment. It's able to create a variety of different scene atmospheres. It is suitable for use on low work surfaces, such as design and reading desks.

The design of the luminaires may get upgraded and the specifications of them may be adjusted by different degree. Please visit our website and check the detail description and specification of the luminaires.

LED  DC 48 V IP20 Bridgelux HEP

	W	LUM	CCT	BEAM	CRI	LXW	H1	H2
MHTA8878	8	344	3000K	20°	80	42x42	105	939

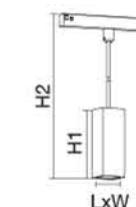



Quickinfo

MHTA8879 @ 3000K, ≥80
8W, 20°, 337LM

Order options

Color temperature
2700K
3000K
4000K

Color rendering Index
≥80
≥90

Beam angle
MHTA8879-20°

Control
Non dim
DALI
PNW DIM
WIRELESS

Installation
Track

PENDANT LIGHT



Pendant track light

Shielded light distribution

Protection class IP 20
3 years' availability guarantee

The round design is simple and integrated with the magnetic track system and application environment. It is suitable for use on low work surfaces, such as design and reading desks. 15-60 degree zoomable lighting is also available for choice.

The design of the luminaires may get upgraded and the specifications of them may be adjusted by different degree. Please visit our website and check the detail description and specification of the luminaires.

LED DC 48 V IP20 Bridgelux HEP

	W	LUM	CCT	BEAM	CRI	Dia	H1	H2
MHTA8879	8	337	3000K	20°	80	Φ40	105	939

Light distribution

3000K CRI≥80

MHTA8879	Spot 20°		
h (m)	E0° (lx)	Φ (m)	
1	1639	0.35	
2	409.7	0.70	
3	182.1	1.05	
4	102.4	1.40	
5	65.6	1.76	

Finish color

For MHTA8879

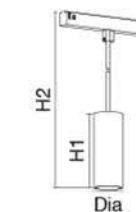



Quickinfo

MHTA8926 @ 6000K, ≥ 80
8W, 340°, 562LM

Order options

Color temperature
2700K
3000K
4000K

Color rendering Index
 ≥ 80
 ≥ 90

Beam angle
MHTA8926-340°

Control
Non dim
DALI
PNW DIM
WIRELESS

Installation
Track



PENDANT LIGHT

Light distribution

3000K CRI ≥ 80

MHTA8926 Flat 340°

h (m)	E0° (lx)	Φ (m)
1	39.8	2.00
2	10.0	4.00
3	4.4	6.00
4	2.5	8.00
5	1.6	10.00

Pendant track light

Shielded light distribution

Protection class IP 20
3 years' availability guarantee

This magnetic pendant track light with globe shape breaks the design of traditional pendant lamp, it can be freely adjusted the height. Using mechanics to adjust the length of the cable. And the creative design can be applied to places with different demands.

The design of the luminaires may get upgraded and the specifications of them may be adjusted by different degree. Please visit our website and check the detail description and specification of the luminaires.

LED DC 48 V IP20 CREE HEP

	W	LUM	CCT	BEAM	CRI	D1	D3	H1	D2	H2
MHTA8926	8	562	3000K	340°	80	$\Phi 150$	$\Phi 30$	358	$\Phi 30$	105



PENDANT LIGHT

Quickinfo

MHTA8927 @ 3000K, ≥80
8W, 60°, 673LM

Order options

Color temperature

2700K

3000K

4000K

Color rendering Index

≥80

≥90

Beam angle

MHTA8927-60°

Control

Non dim

DALI

PNW DIM

WIRELESS

Installation

Track

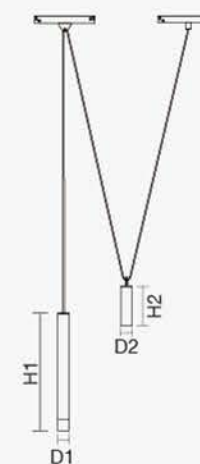
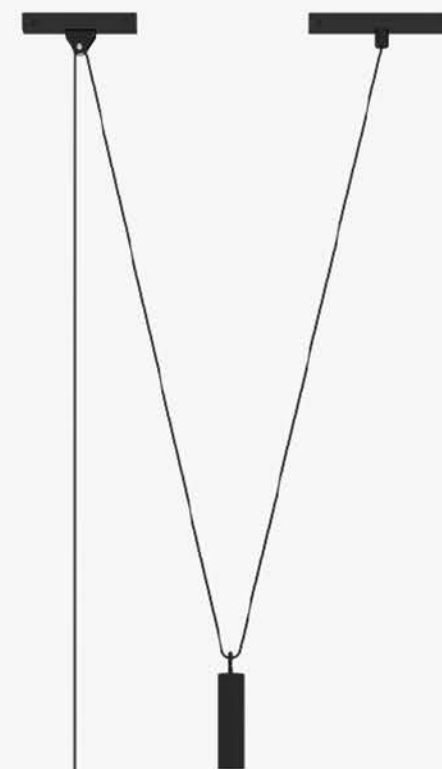

Light distribution

3000K CRI≥80

MHTA8927 Flat 60°

h (m)	E0° (lx)	Φ (m)
1	693.4	1.02
2	173.4	2.04
3	77.1	3.06
4	43.3	4.08
5	27.7	5.10

Pendant track light

Shielded light distribution

Protection class IP 20

3 years' availability guarantee

This adjustable height of magnetic pendant track light with cylinder lamp to provide focusing lighting breaks the design of traditional pendant lamp, it can be freely adjusted the height of. And the creative design can be applied to places with different demands.

The design of the luminaires may get upgraded and the specifications of them may be adjusted by different degree. Please visit our website and check the detail description and specification of the luminaires.

LED  DC 48 V IP20 Bridgelux HEP

	W	LUM	CCT	BEAM	CRI	D1	H1	D2	H2
MHT8927	8	673	3000K	60°	80	Φ30	315	Φ30	105



Quickinfo

MHTA8871 @ 3000K, ≥80
18W, 301053LM

MHTA8871A @ 3000K, ≥80
20W, 36°, 1511LM

Order options

Color temperature

2700K

3000K

4000K

Color rendering Index

≥80

≥90

Beam angle

MHTA8871-30°

MHTA8871A-36°

Control

Non dim

DALI

PNW DIM

WIRELESS

Installation

Track

LINEAR LIGHT

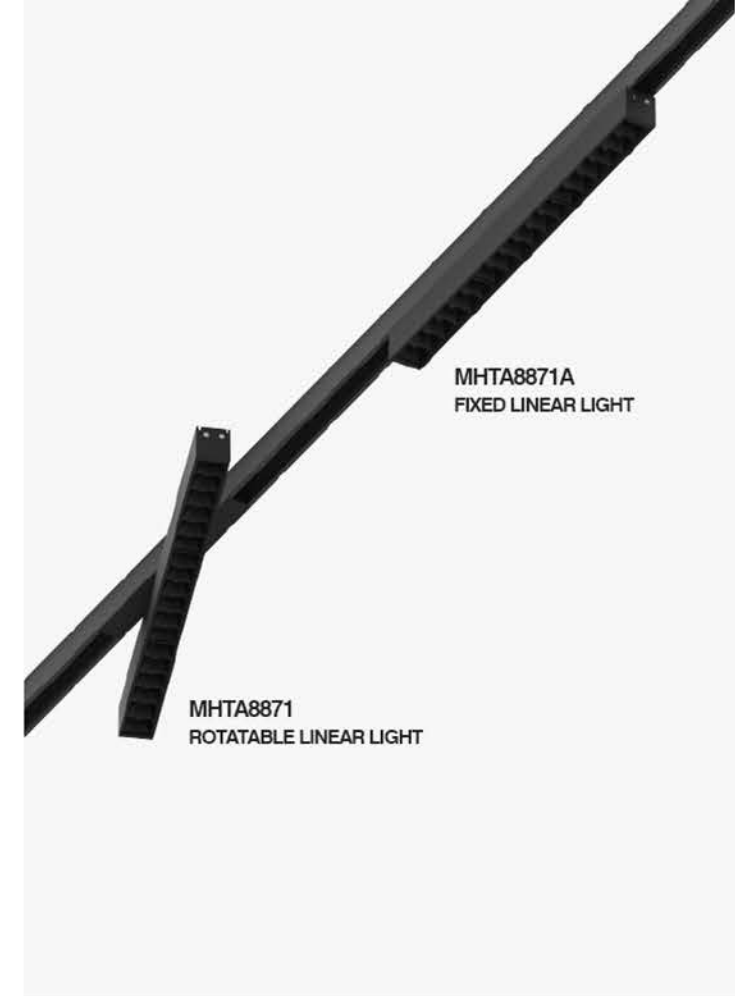

Grille linear track light

Symmetric light distribution

Protection class IP 20

3 years' availability guarantee

Grille style is currently fashion shape with Lens to provide the perfect anti-glare effect. We provide fixable and rotatable for your option. Customers can change different shapes according to their preferences to beautify their lighting environment.

The design of the luminaires may get upgraded and the specifications of them may be adjusted by different degree. Please visit our website and check the detail description and specification of the luminaires.

LED DC 48 V IP20 NICHIA HEP

	W	LUM	CCT	BEAM	CRI	L	T	H
MHTA8871	18	1053	3000K	30°	80	295.7	23	24.5
MHTA8871A	20	1511	3000K	36°	80	583	23	24.5

Light distribution

3000K CRI≥80

MHTA8871 Spot 30°

h (m)	E0° (lx)	Φ (m)
1	1163	0.52
2	290.7	1.04
3	129.2	1.56
4	72.7	2.08
5	46.5	2.60

MHTA8871A Spot 36°

h (m)	E0° (lx)	Φ (m)
1	2807	0.59
2	701.8	1.17
3	311.9	1.76
4	175.4	2.35
5	112.3	2.94

Finish color

For MHTA8871 / MHT8871A

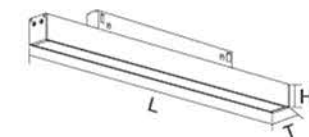



Quickinfo

MHTA8873 @ 3000K, ≥80
12W, 100°, 315LM

MHTA8873A @ 3000K, ≥80
18W, 100°, 547LM

Order options

Color temperature

2700K
3000K
4000K

Color rendering Index

≥80
≥90

Beam angle

MHTA8873-100°
MHTA8873A-100°

Control

Non dim
DALI
PNW DIM
WIRELESS

Installation

Track

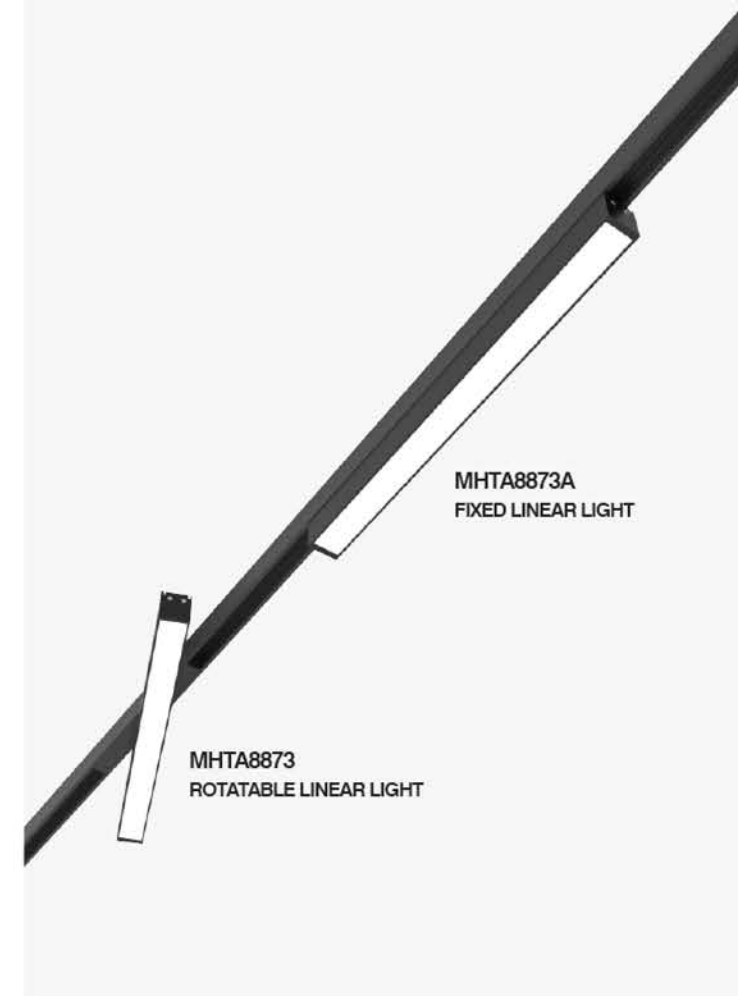

Flood linear track light

Wide beam light distribution

Protection class IP 20
3 years' availability guarantee

This flood light version is matching with PC diffuser, light output is soft and not dazzling. Fixable and rotatable version can be selected. It's the best choice for mainless or hidden lighting that is popular in the lighting market.

The design of the luminaires may get upgraded and the specifications of them may be adjusted by different degree. Please visit our website and check the detail description and specification of the luminaires.

LED  DC 48 V IP20 NICHIA HEP

	W	LUM	CCT	BEAM	CRI	L	T	H
MHTA8873	12	315	3000K	100°	80	295.7	23	24.5
MHTA8873A	18	547	3000K	100°	80	583	23	24.5

LINEAR LIGHT

Light distribution

3000K CRI≥80

MHTA8873		Flat 100°	
h (m)	E0° (lx)	Φ (m)	
1	217.1	2.41	
2	54.3	4.82	
3	24.1	7.23	
4	13.6	9.64	
5	8.7	12.0	

MHTA8873A		Flat 100°	
h (m)	E0° (lx)	Φ (m)	
1	314.3	1.92	
2	78.6	3.84	
3	34.9	5.76	
4	19.7	7.67	
5	12.6	9.59	

Finish color

For MHTA8873 / MHTA8873A

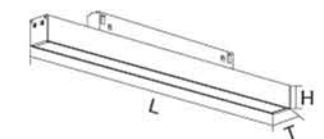

TRACK

TRACK

Low Voltage (48V) track system provides freedom and flexibility in design as to satisfy all technical and user needs.



MHTA6

Low voltage track ceiling / suspension

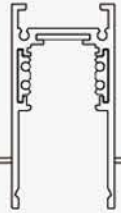

MHTA4

Low voltage track recessed

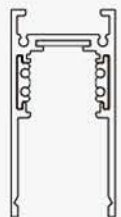

MHTA2

Low voltage track ceiling / suspension

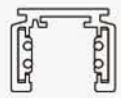

MHTA1

Standard low voltage track ceiling / suspension



TRACK

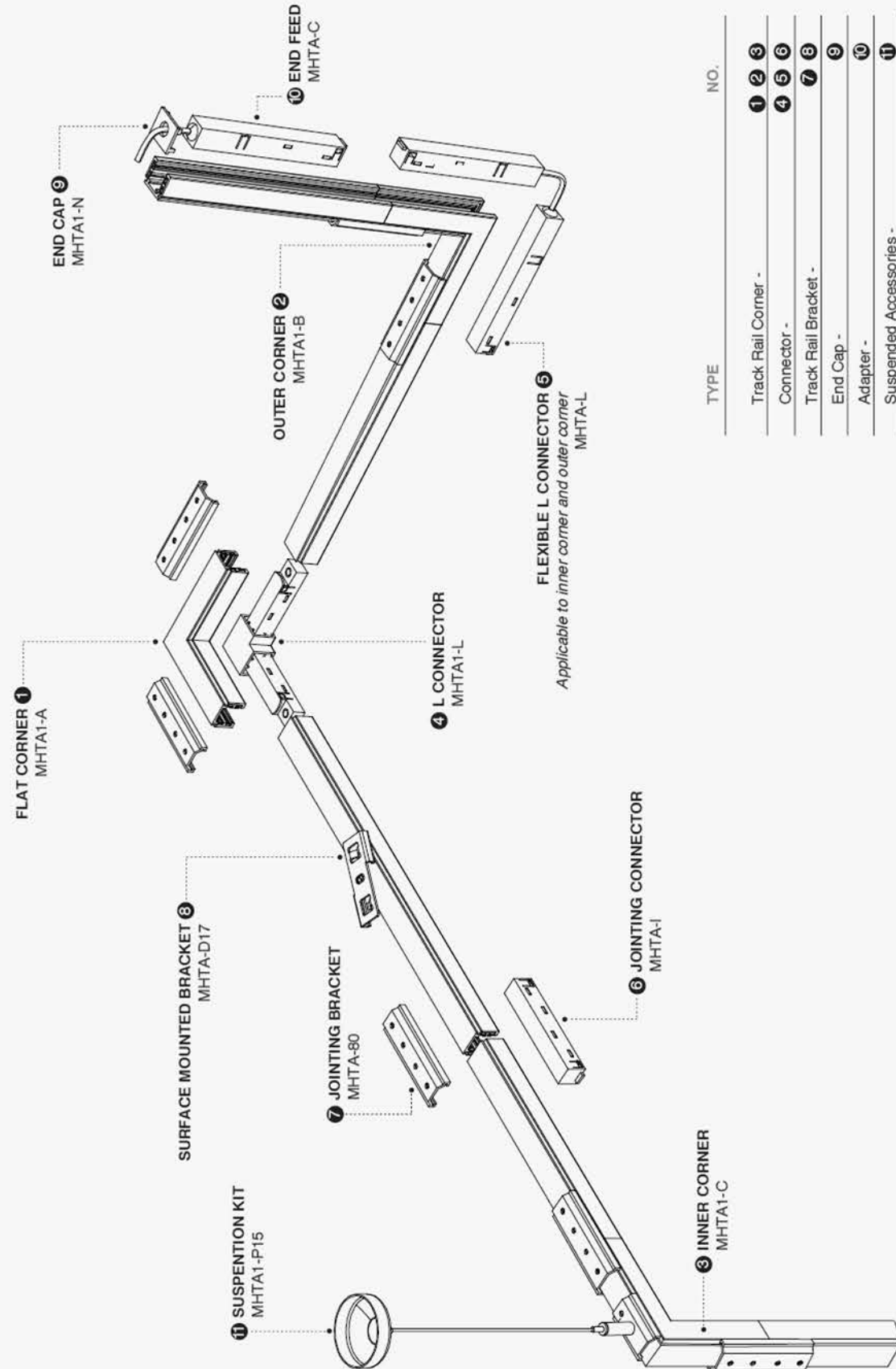

TYPE	NO.
Track Rail Corner -	1 2 3
Connector -	4 5 6
Track Rail Bracket -	7 8
End Cap -	9
Adapter -	10
Suspended Accessories -	11

TRACK

MAGNETIC TRACK
MHTA1



STANDARD LOW VOLTAGE TRACK
CEILING / SUSPENSION

- External extruded body in aluminum + copper conductors + PC
- Matching with track installation accessories, connectors and power supply.
- Available to use the simple and easy interchangeable lighting, including: fixed / adjustable linear modules, fixed / adjustable spots

DC 48 V IP20

Quickinfo

Control
Non dim
DALI
PNW DIM
WIRELESS

Length
MHTA1-100 [1000mm]
MHTA1-200 [2000mm]
MHTA1-300 [3000mm]

Finish
RAL 9005 RAL 9016

Bearing capacity
Distance 1000 mm
Fastening distance recommendation

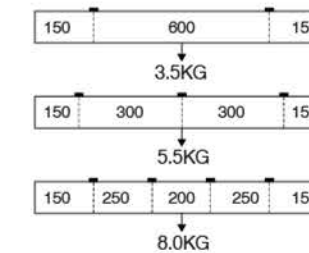

Installation

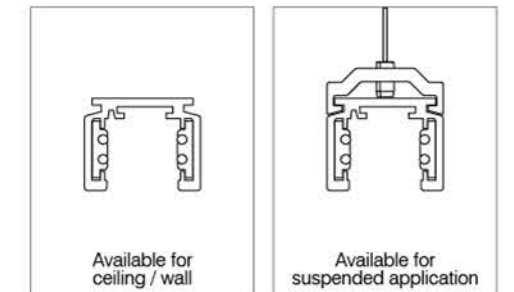

TRACK

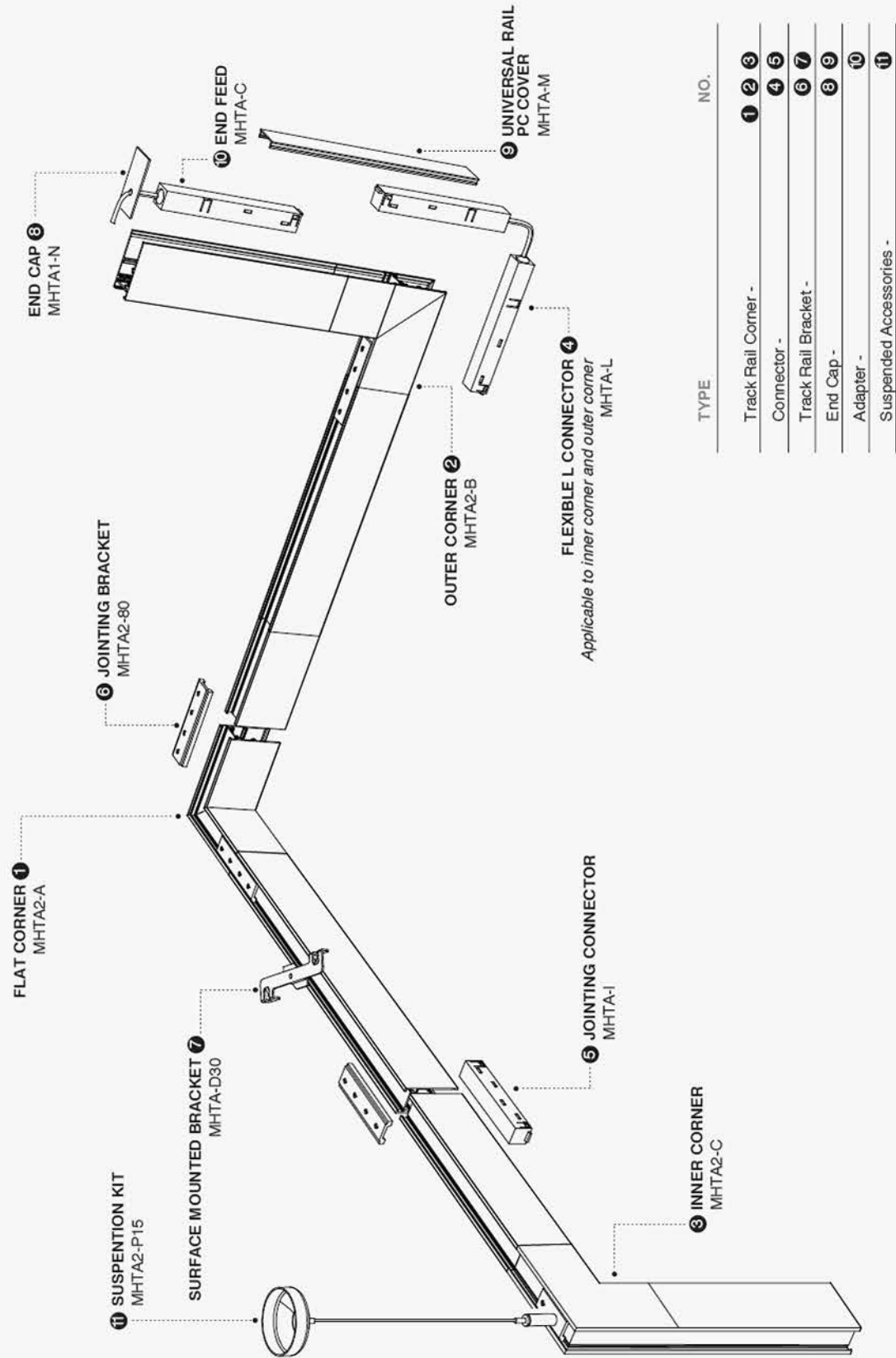

TYPE	NO.
Track Rail Corner -	1 2 3
Connector -	4 5
Track Rail Bracket -	6 7
End Cap -	8 9
Adapter -	10
Suspended Accessories -	11

MAGNETIC TRACK
MHTA2

DC 48 V IP20

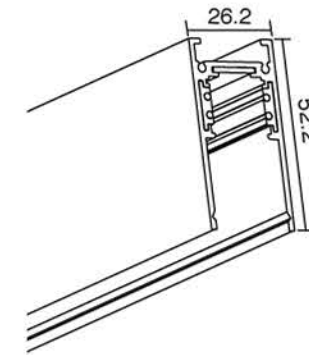

Quickinfo

Control
Non dim
DALI
PNW DIM
WIRELESS

Length
MHTA2-100 [1000mm]
MHTA2-200 [2000mm]
MHTA2-300 [3000mm]

Finish
RAL 9005 RAL 9016

Bearing capacity
Distance 1000 mm
Fastening distance recommendation

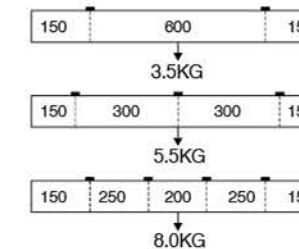

Installation

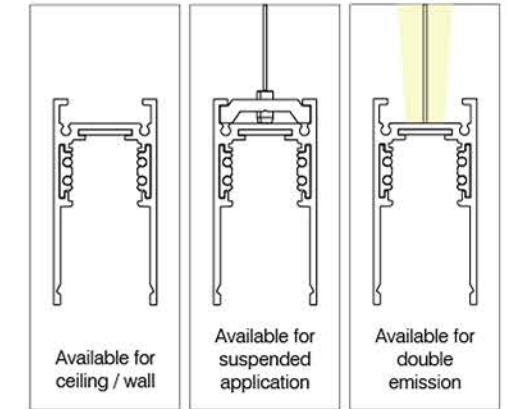

LOW VOLTAGE TRACK CEILING / SUSPENSION

- External extruded body in aluminum + copper conductors + PC.
- Matching with track installation accessories, connectors and power supply.
- Available to use the simple and easy interchangeable lighting, including: fixed linear modules, fixed spots.



TRACK

TRACK

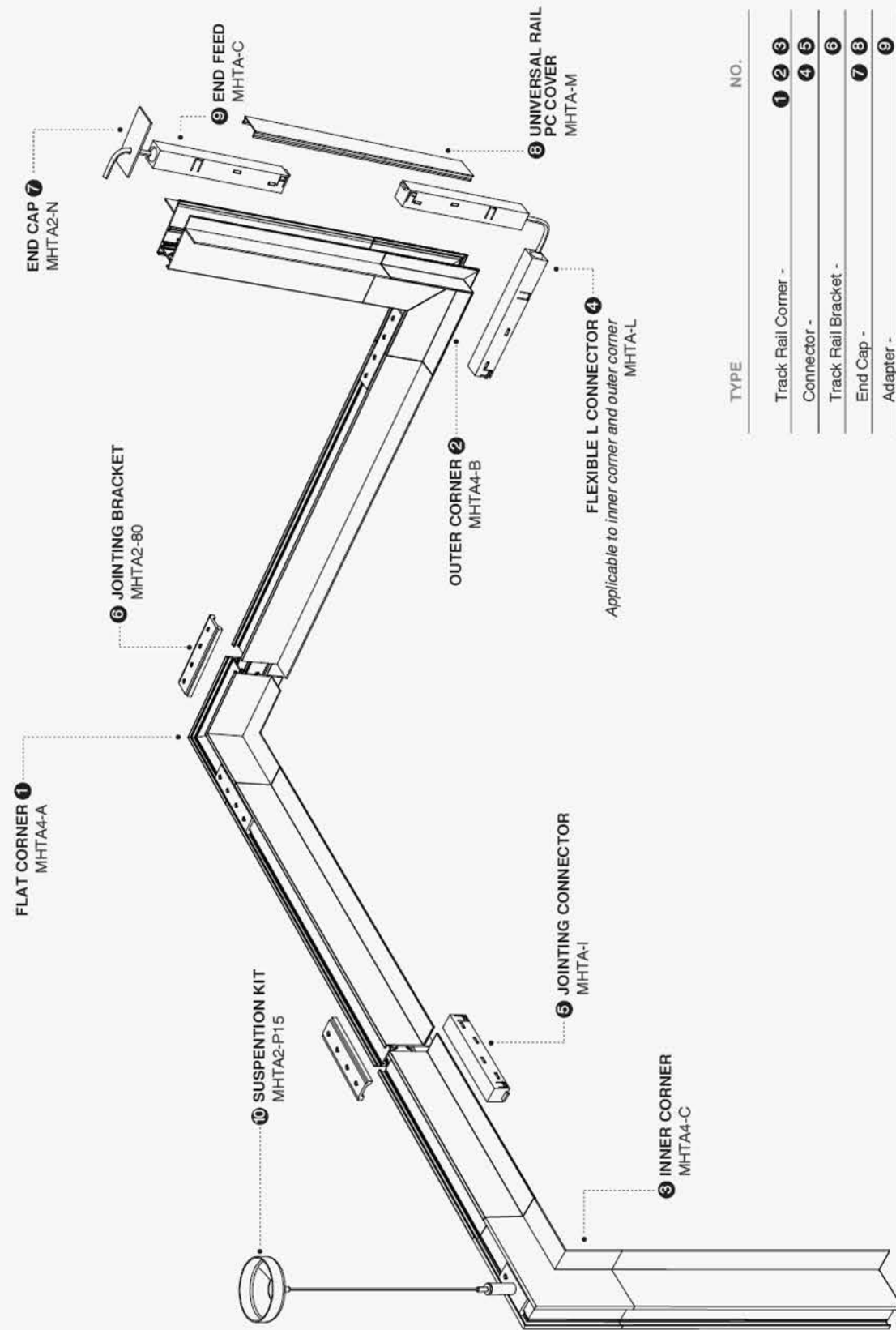

TYPE	NO.
Track Rail Corner -	1 2 3
Connector -	4 5
Track Rail Bracket -	6
End Cap -	7 8
Adapter -	9
Suspended Accessories -	10

TRACK



MAGNETIC TRACK MHTA4

DC 48 V IP20

LOW VOLTAGE TRACK CEILING / SUSPENSION

- External extruded body in aluminum + copper conductors + PC.
- Matching with track installation accessories, connectors and power supply.
- Available to use the simple and easy interchangeable lighting, including: fixed linear modules, fixed spots.

Quickinfo

Control
 Non dim
 DALI
 PNW DIM
 WIRELESS

Length
 MHTA4-100 [1000mm]
 MHTA4-200 [2000mm]
 MHTA4-300 [3000mm]

Finish
 ■ RAL 9005 □ RAL 9016

Bearing capacity
 Distance 1000 mm
 Fastening distance recommendation

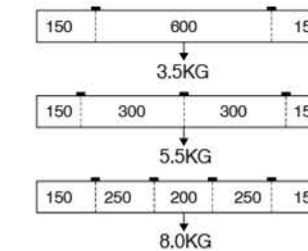

Installation

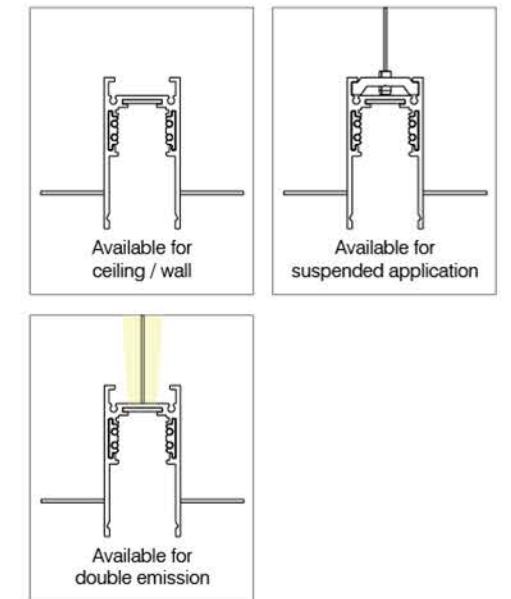

TRACK

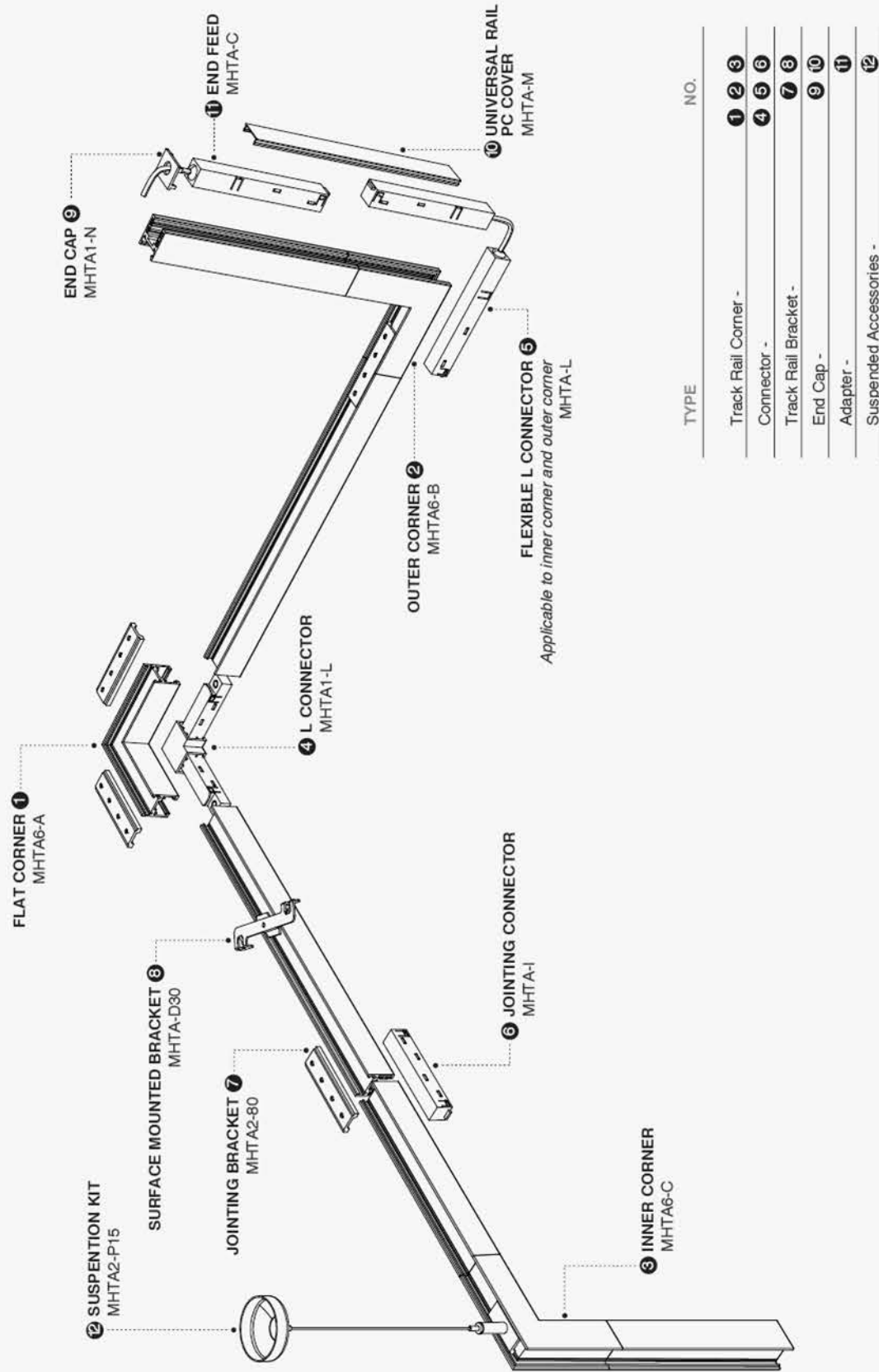

TRACK

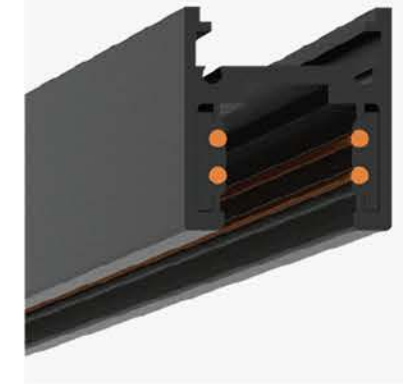

MAGNETIC TRACK MHTA6

DC 48 V IP20

LOW VOLTAGE TRACK CEILING / SUSPENSION

- External extruded body in aluminum + copper conductors + PC
- Matching with track installation accessories, connectors and power supply.
- Available to use the simple and easy interchangeable lighting, including: fixed / adjustable linear modules, fixed / adjustable spots

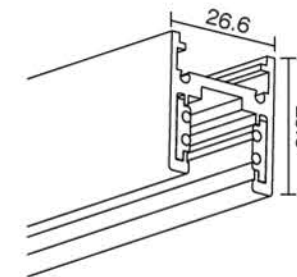

Quickinfo

Control
 Non dim
 DALI
 PNW DIM
 WIRELESS

Length
 MHTA6-100 [1000mm]
 MHTA6-200 [2000mm]
 MHTA6-300 [3000mm]

Finish
 ■ RAL 9005 □ RAL 9016

Bearing capacity
 Distance 1000 mm
 Fastening distance recommendation

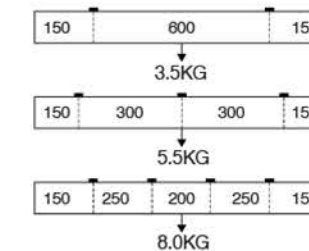

Installation

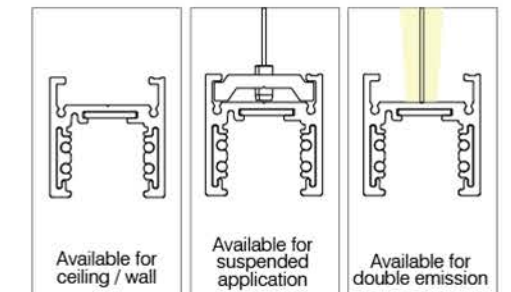

TRACK ACCESSORIES

Track Rail Corner

Available in pendant and surface version



FLAT CORNER
MHTA1-A
Available for MHTA1



OUTER CORNER
MHTA1-B
Available for MHTA1

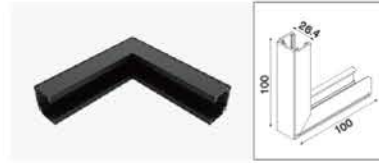

INNER CORNER
MHTA1-C
Available for MHTA1



FLAT CORNER
MHTA2-A
Available for MHTA2



OUTER CORNER
MHTA2-B
Available for MHTA2



INNER CORNER
MHTA2-C
Available for MHTA2



FLAT CORNER
MHTA4-A
Available for MHTA4

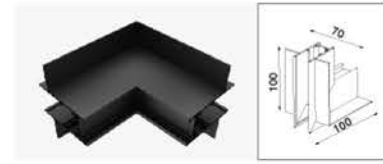

OUTER CORNER
MHTA4-B
Available for MHTA4



INNER CORNER
MHTA4-C
Available for MHTA4



FLAT CORNER
MHTA6-A
Available for MHTA6



OUTER CORNER
MHTA6-B
Available for MHTA6

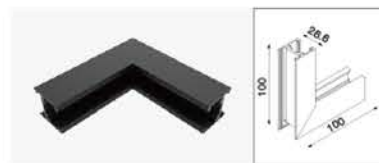

INNER CORNER
MHTA6-C
Available for MHTA6

CONNECTOR

Available in pendant and surface version



L CONNECTOR
MHTA1-L
Available for MHTA1



FLEXIBLE L CONNECTOR
MHTA-L
Available for MHTA1 / MHTA2 / MHTA4 / MHTA6



JOINING CONNECTOR
MHTA-I
Available for MHTA1 / MHTA2 / MHTA4 / MHTA6

TRACK ACCESSORIES

ADAPTER

Available in pendant and surface version



FLAT CORNER
MHTA1-C
Available for MHTA1 / MHTA2 / MHTA4 / MHTA6



IN-TRACK TRANSFORMER
MHTA-DY-100
Available for MHTA1 / MHTA2 / MHTA4 / MHTA6

TRACK RAIL BRACKET

Available in pendant and surface version



JOINTING BRACKET
MHTA-80
Available for MHTA1



SURFACE MOUNTED BRACKET
MHTA-D30
Available for MHTA2 / MHTA6



POWER TRANSFORMER
MHTA-150W-48
Available for MHTA1 / MHTA2 / MHTA4 / MHTA6



IN-TRACK TRANSFORMER
MHTA-DY-150
Available for MHTA1 / MHTA2 / MHTA4 / MHTA6



POWER TRANSFORMER
MHTA-200W-48
Available for MHTA1 / MHTA2 / MHTA4 / MHTA6



IN-TRACK TRANSFORMER
MHTA-DY-230
Available for MHTA1 / MHTA2 / MHTA4 / MHTA6



JOINTING BRACKET
MHTA2-80
Available for MHTA2 / MHTA4 / MHTA6



SURFACE MOUNTED BRACKET
MHTA-D17
Available for MHTA1

TRACK ACCESSORIES

END CAP

Available in pendant and surface version



END CAP
MHTA1-N
Available for MHTA1 / MHTA6



END CAP
MHTA2-N
Available for MHTA2 / MHTA4



UNIVERSAL RAIL PC COVER
MHTA-M
Available for MHTA1 / MHTA2 / MHTA4 / MHTA6

SUSPENDED ACCESSORIES

Available in pendant version



SUSPENDED KIT
MHTA1-P15
Available for MHTA1



SUSPENDED KIT
MHTA2-P15
Available for MHTA2 / MHTA4 / MHTA6