

KETAI



LED LIGHTING
Design & Manufacture
2019

KETAI INDUSTRIES LIGHTING CO., LTD

Ketai Building, 4 Mashe New Street
Lishui, Nanhai, Post code 528244, Foshan
Guangdong, China

Phone: +86 757 8560 7707

Fax: +86 757 8560 3675

e-mail: sales@ketailighting.com



www.ketailighting.com



Catalog download

KETAJ

LED LIGHTING

2019 - 2020

LESS



LESS

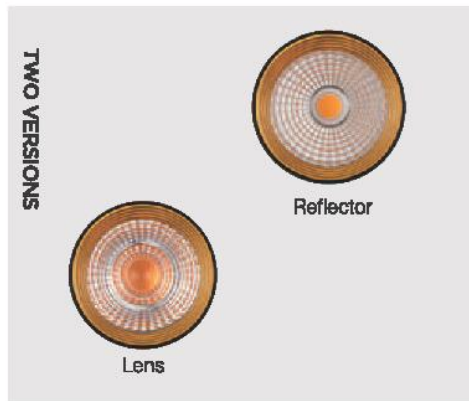

LESS





Replaceable Accessories



golden ring



black ring

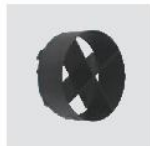

wall wash ring



honeycomb

TAURUS



TAURUS



MULTIS ROUND



MULTIS ROUND



SL389 P159



MHT8848 P119



KT6796 P92



XD2153 P132



WL612 P157



XD2158 P134

MULTIS SQUARE



MULTIS SQUARE



EXTREM NARROW BEAM ANGLE



EXTREM NARROW BEAM ANGLE



CUP



CUP



XD2127 / XD2128 P146



KT6913 P78



KT6943 P79



KT6914 P79

BOWL



BOWL



RETROFIT DOWNLIGHTS



RETROFIT DOWNLIGHTS



CONE



CONE



DRUM



DRUM



MHT8757 P120



KT6679-1 P98



KT6679-2 P98

SARDINE



SARDINE



ABRAS



ABRAS



- Integration design
- Anti glare with Fresnel lens
- 5 sizes options with different wattage

IVORY



IVORY



- Adjust easily
- Deeply anti-glare
- 5 sizes options with different wattage



KT6775 / KT6776 / KT6777 / KT67778 / KT6779 P87

THUNDER



THUNDER



KT6781 P88



KT6782 P88

HORN



HORN

- Integration design
- Anti glare with Fresnel lens
- 3 sizes options with different wattage



KT6756A / KT6757A / KT6758A P82



KT6756C / KT6757C / KT6758 P84



KT6756B / KT6757B / KT6758B P83

HUZAR



HUZAR



KT6760 / KT6762 / KT6764 / KT6766 P86

ZOOMER



ZOOMER

8° NARROW SPOT



55° FLOOD WASHER



MHT8837 / MHT884 P117

- Beam angle can be adjusted from 8 to 55 deg.
- 4 installation options (recessed, track, surface mounted and suspended)
- 2 sizes options (big one is 30W the small one is 15W)



KF1059 / KF1060 P152



XD2211 / XD2212 P138



KT6985 / KT6985-1 P72

CAN



CAN



MHT8890 / MHT8891 / MHT8892 / MHT8893 P110



MHT8890A / MHT8891A / MHT8892A / MHT8893A P111



SMRITI



SMRITI



OSLO



OSLO



XD2131 / XD2187 / XD2188 P122

- 30mm thickness
- DOB version without driver
- 3 installation options
- 3 sizes options
($\Phi 90\text{mm}$, $\Phi 105\text{mm}$, $\Phi 120\text{mm}$)



KTK1 8837 / KTK1 8835 / KTK1 8836 P113



KT6793 / KT6794 / KT6795 P71

PIPE



PIPE



- Heat dissipation design
- High quality powder coating process
- 3 sizes options with different wattage

ROBOT



ROBOT



XD2228 P129



XD2229 P129



XD2139 P125



XD2144 P126



XD2142 P125



XD2143 P126



XD2232 P128



XD2233 P128



XD2230 P127



XD2231 P127

IBIS





ASTREA

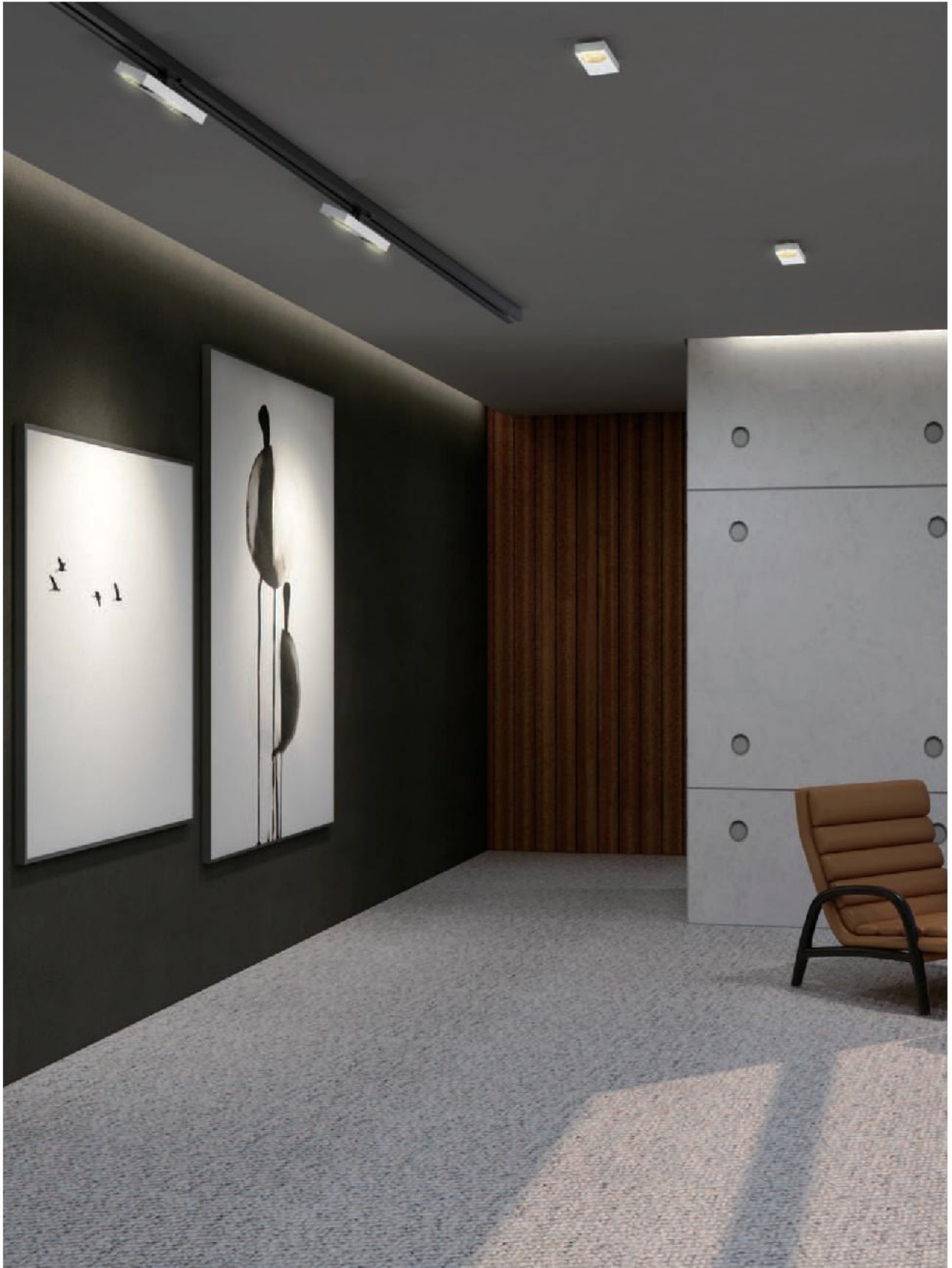

ASTREA



- 10 types of LENS are available for selection
- Meeting different lighting scenarios
- Ceiling and wall mounting ways for different lighting options

ANTORCHA



ANTORCHA



XD2197 / XD2198 / XD2200 P135



- Modeling simplicity
- Low UGR
- 3 sizes options
($\Phi 76\text{mm}$, $\Phi 98\text{mm}$, $\Phi 116\text{mm}$)

ILUSION



ILUSION



- Cost-effective
- Anti-glare
- 3 sizes options
(76x76mm, 96x96mm, 116x116mm)

PORTO



PORTO



- Modern & chic design
- Applying in dining desk or front desk
- two installation options



KT6756 / KT6757 / KT6758 P81



XD2205 / XD2206 / XD2207 P137

VERINA



VERINA



SL372 / SL373 / SL374 P154

- Modern & chic design
- Applying in dining desk or front desk
- 3 sizes options the small, medium and big one

LED LINEAR



LED LINEAR



WL572 P164

- Ultra-slim design
- Anti glare with diffuser
- Motion sensor for model KF1027A



KT1027A P149

JELLYFISH



JELLYFISH



- 2 options for installation
- 2 sizes options with different wattage
- Golden / Red / Black 3 colors for choosing



ECLIPSE

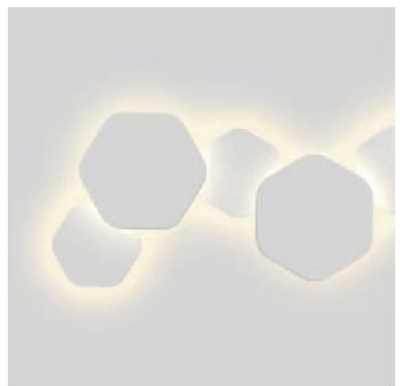
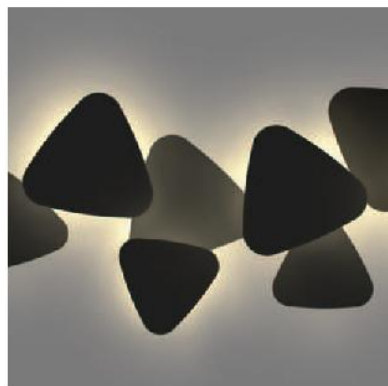
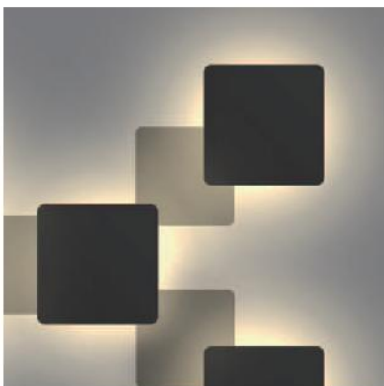

ECLIPSE



WL601B / WL602B / WL603B
P171



WL601C / WL602C / WL603C
P172



WL601A / WL602A / WL603A
P170



WL601 / WL602 / WL603
P169

PLUTO



PLUTO

- IP54 waterproof
- Round and square shape for option
- 3W and 10W available for selection
- Application in kitchen plinths, corridor, checking areas and steps



ABRAS



ABRAS

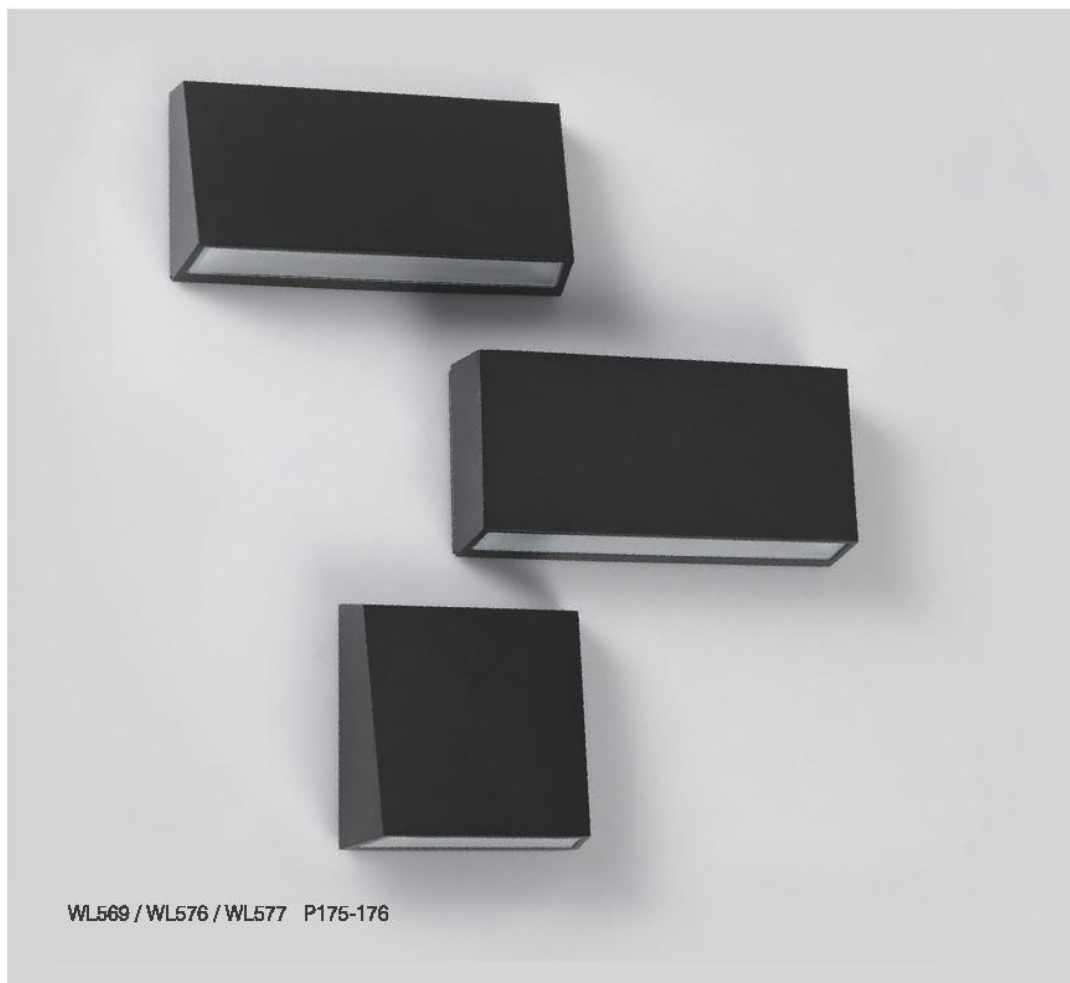

WL569 / WL576 / WL577 P175-176



WL558 P176

- IP65 waterproof
- Modern & chic design
- Applying in any outside case

CERTUS



CERTUS



WL581 / WL582 / WL583 P177

- IP65 waterproof outdoor light
- DOB version without driver
- 3 different types for lighting



WL581B / WL582B / WL583B P179



WL581A / WL582A / WL583A P178



JOIN US

Let Inspiration Talk



WE LOVE TO WORK & WE LOVE WHERE WE WORK

Ketai Industries Lighting Co., Ltd. was founded in 1999 in Foshan, Guangdong of China, focusing on researching, development and production of lighting including led downlights, led track lights, led wall lights, led ceiling lights, led pendant lights and led outdoor lights.

Our factory covers an area of 40000 square meters, including the die-casting workshop, stamping workshop, powder coating workshop, and assembly workshop.

We have 500 employees, our greatest advantage is to design, develop and produce the special, creative, high-tech LED lights. No matter what kinds of LED lights you want, just tell us your demand, the best solution would be provided by our professional engineers.

Our well experienced 30 engineers in the R&D dept. customize available solutions for various lighting projects and, free design drawing can be provided according to customer's demand.

We are ISO 9001 certified manufacturer. Most items of our products are approved by CE, RoHS,UL, SAA Certificates.



QUALIFIED LIGHTS

Made in KETAI Lighting

Well-equipped apparatus and instruments, and strict quality control throughout all stages of production;

Owning R&D team with 30 experienced qualified engineers;

5-10 new items are currently distributed to market every month;

One stop of complete solution for lighting projects;

Unique imagination and designing, advanced developing technologies;

Strict quality parameters conformed with standards.



QUALIFIED SUPPLY CHAIN

CHIPS



DRIVERS



ELECTRICAL COMPONENTS



PRODUCTION PROCESS

Thanks to our perfect PMC system, production system and strict quality control system with perfect inspection process.

All new products undergoes stringent validation and age testing prior to production.

All products undergoes "burn in" test prior to packing.

All orders are QC inspected by our staff prior to shipping.

All products in mentioned have independent certified to meet customer's need.

Global Excellence Made in KETAI Lighting

We have 500 employees, our greatest advantage is to design, develop and produce the special, creative, high-tech LED lights. No matter what kinds of LED lights you want, just tell us your demand. The best solution would be provided by our professional engineers, our well experienced 30 engineers in the R&D dept. customize available solutions for various lighting projects, free design drawing can be provided according to customer's demand.

We are ISO 9001 certified manufacturer. Most items of our products are approved by CE, RoHS, SAA etc. certificates.

We are keeping on running with the vision focusing on service, education, brand and technology support. With 20 years of practice and experience, Ketai lighting is getting a good reputation in commercial lighting industry in the world and has an extensive sales network.





Lighting Solution Made in KETAI Lighting

Thanks for our unique and creative design, our product is introduced in mainly application, from large residential or public buildings to commercial, institutional or public spaces.

BAR & RESTAURANT



OFFICE



RETRAL & SHOPPING MALL

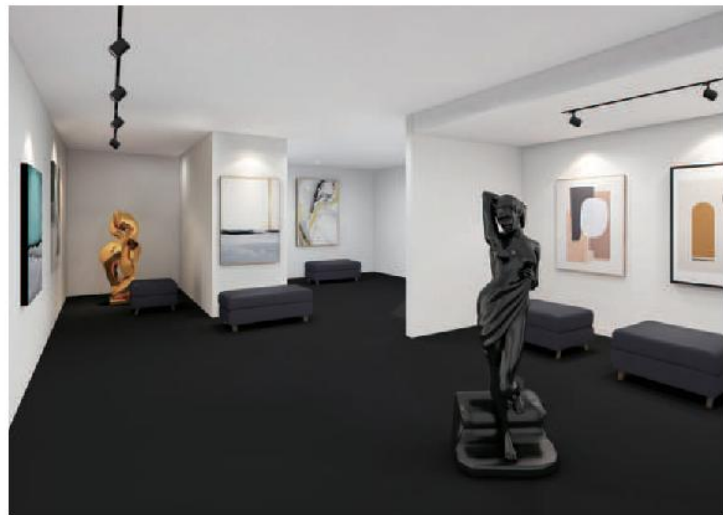

GALLERY



RESIDENTAL

Lighting Completeness Made in KETAI Lighting

We are ISO9001 certified manufacturer and most of our products are approved by CE, CB, UL, SAA, GS, TUV and CCC certifications. The quality of our products is assured by our implementing QS ERP system and well-equipped testing lab. With more than 20 years experience in lighting fixtures exporting field, our market has covered Europe South America, Mid-East and Russia.

The R&D Department has 30 engineers and they independently research and develop new products each year.

Our engineers have the comprehensive ability of structure development, optical design, thermal design to meet customers' various demands.

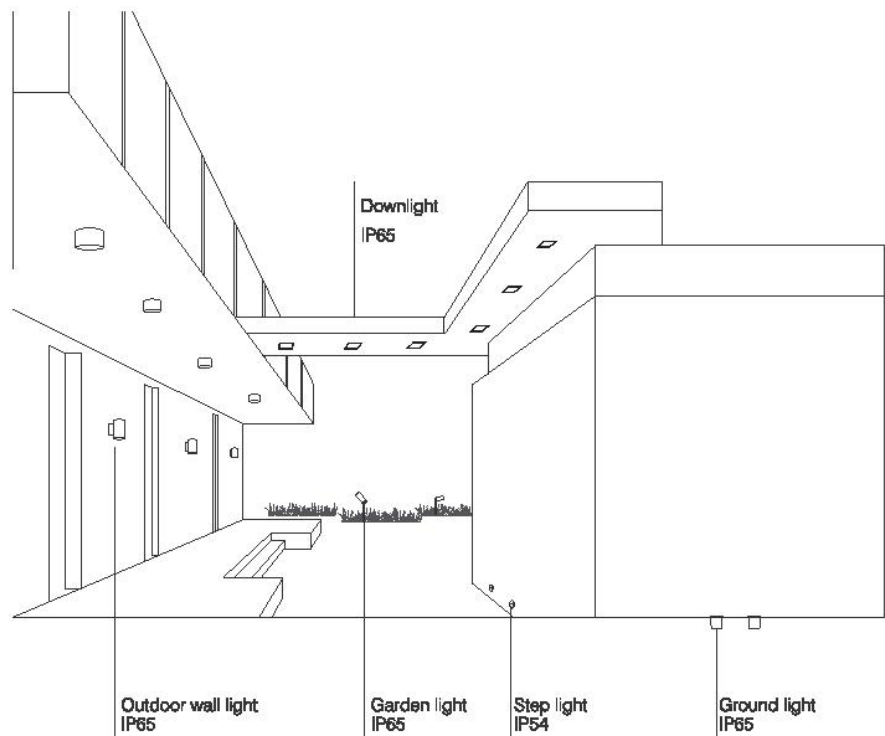

Ketai Lighting is a commercial lighting manufacturer specialized in a diverse range of interior light with exterior light. The product range covers LED recessed downlight, LED track light, LED ceiling light, LED wall light, LED magnetic light system and LED outdoor light.

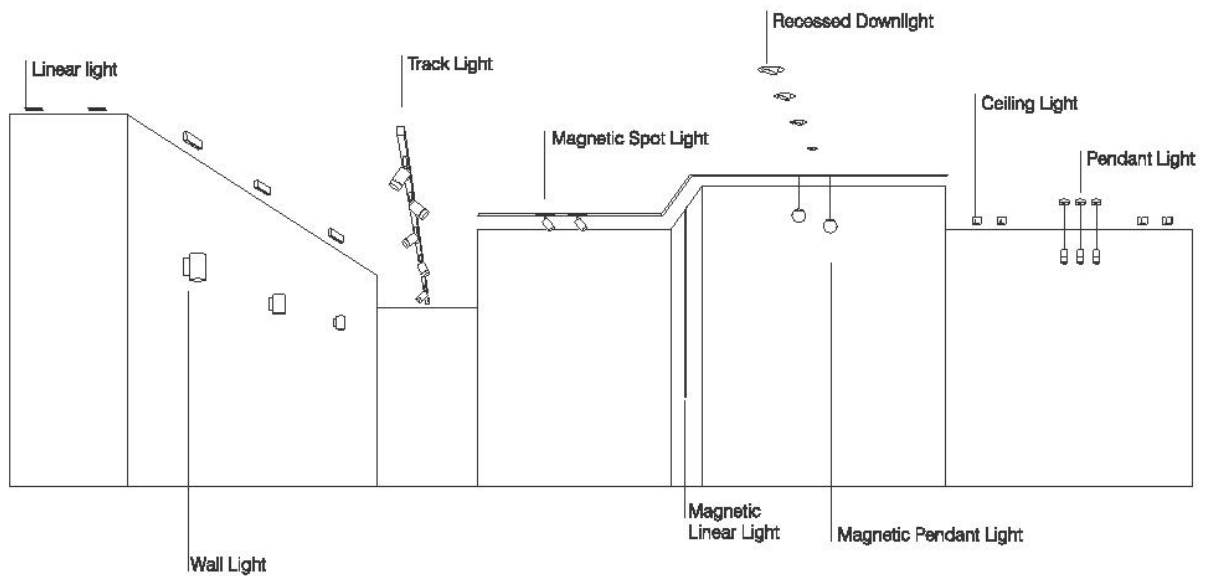

Value Added Service Made in KETAI Lighting

The greatest advantage of ours is to design, develop and produce the special, creative, high-tech LED lights. No matter what kinds of LED lights you like, just tell us your demand, the best solution would be provided by our professional engineers, 30 well experienced engineers in the R&D dept. And also we customize available tailored solutions for various lighting projects.

Using what we have learned and accumulated experience, we are constantly moving forward and creating new concepts. This proprietary technology allows us to tailor our customers.

Tailor-made is an alternative solution, which means

- 1) customizing the size of the luminaire according to the size of the area used;
- 2) maintaining the color of the luminaire in harmony with the overall color of the area used and the surrounding environment;
- 3) design style of the luminaire to meet the needs of the decoration style of the use of the regional space;
- 4) the performance of the luminaire meeting the needs of specific application scenarios, such as waterproof, moisture-proof and corrosion-resistant.



Photograph in Guangdong Daguang Museum

Family Index

FAMILY INDEX



LESS
P1



TAURUS
P5



CUP
P13



BOWL
P15



RETROFIT DOWNLIGHTS
P17



CONE
P19



THUNDER
P29



HORN
P31



HUZAR
P33

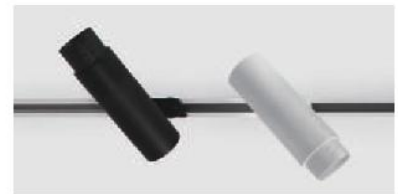

ZOOMER
P35



ROBOT
P45



IBIS
P45



ASTREA
P47



VERINA
P57

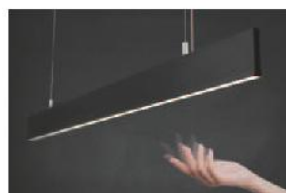

LED LINEAR
P59



JELLYFISH
P61

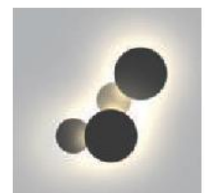

ECLIPSE
P63

Family Index



MULTIS ROUND
P7



MULTIS SQUARE
P9



EXTREM NARROW BEAM ANGLE
P11



DRUM
P21



SARDINE
P23



ABRAS
P25

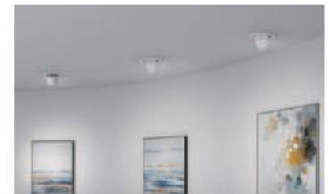

IVORY
P27

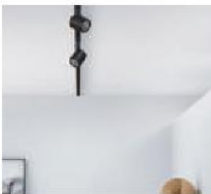

CAN
P37

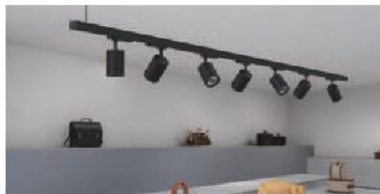

SMRITI
P39



OSLO
P41

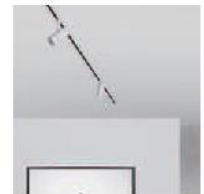

PIPE
P43



ANTORCHA
P51

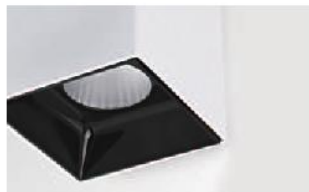

ILUSION
P53



PORTO
P55



PLUTO
P65



LACUNA
P67



CERTUS
P69

Index

RECESSED DOWNLIGHT

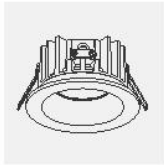

KT6594 / KT6594A
P90

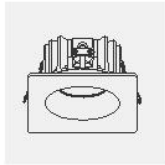

KT6596 / KT6596A
P91

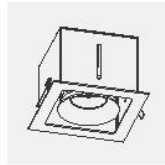

KT6644-1
P93

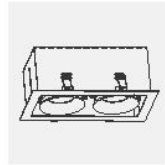

KT6644-2
P93

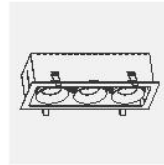

KT6644-3
P94

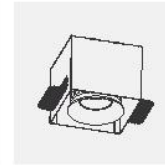

KT6645-1
P94

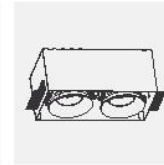

KT6645-2
P95

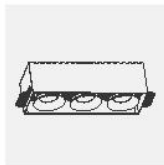

KT6646-3
P95



KT6656
P96



KT6657
P96

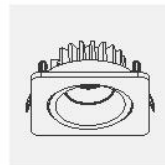

KT6659-1
P97



KT6659-2
P97



KT6679-1
P98



KT6679-2
P98



KT6696
P99

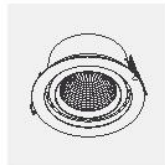

KT6697
P99



KT6698
P100



KT6758 / KT6757
KT6758
P81

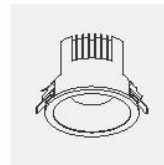

KT6758A / KT6757A
KT6758A
P82

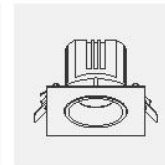

KT6758B / KT6757B
KT6758B
P83

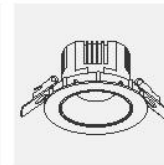

KT6758C / KT6757C
KT6758C
P84



KT6759 / KT6761
KT6763 / KT6765
KT6767
P85



KT6760 / KT6762
KT6764 / KT6766
P86



KT6775 / KT6776
KT6777 / KT6778
KT6779
P87



KT6781
P88



KT6782
P88

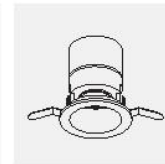

KT6787
P89

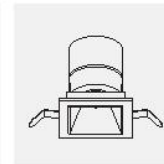

KT6788
P89



KT6793 / KT6794
KT6795
P71

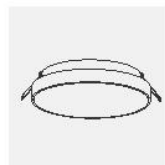

KT6798
P92

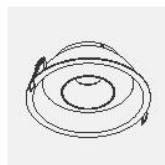

KT6828
P80



KT6827
P80



KT6830
P100

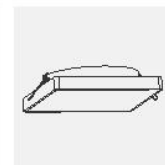

KT6867
P92

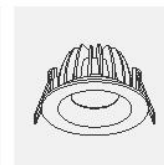

KT6913
P78



KT6914
P79

KT6915
P78

KT6943
P79

KT6955 / KT6956
P75

KT6957 / KT6958
P76

KT6967
P77

KT6967-2
P77



KT6985 / KT6985-1
P72

KT6986
P101

KT6987
P101

KT6988
P102

KT6989 / KT6989A
P73

KT6990 / KT6990A
P74

TRACK LIGHT



KTK1 8834
KTK1 8835
KTK1 8836 P113

MHT103
P114

MHT8575
P120

MHT8583
P114

MHT8596A
MHT8596B
MHT8597 P115

MHT8630 / MHT8631
P116

MHT8637 / MHT8647
P117



MHT8841 / MHT8841A
P118

MHT8846
P119

MHT8848
P119

MHT8866 / MHT8867
MHT8868
P103

MHT8867
P104

MHT8871
P105

MHT8872
P120



MHT8874 / MHT8875
P107

MHT8877 / MHT8880
MHT8881
P108

MHT8877A / MHT8880A
P109

MHT8882A-DALI
MHT8882A
P108

MHT8883
P104

MHT8890 / MHT8891
MHT8892 / MHT8893
MHT8890A / MHT8891A
MHT8892A / MHT8893A
P110 / P111

MHT8890B / MHT8891B
P112

Index

SURFACE MOUNTED LIGHT

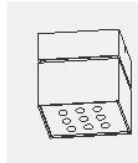

XD2021
P142



XD2021B
P142



XD2022A
P143

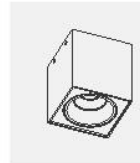

XD2036-1
P144

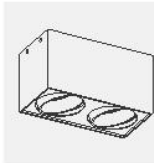

XD2036-2
P144



XD2048
P147

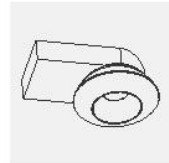

XD2077-1
P121

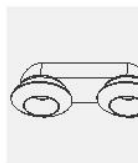

XD2077-2
P121

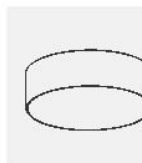

XD2081
P148

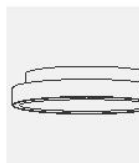

XD2096 / XD2097
P145

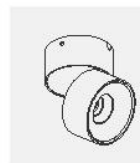

XD2104
P143

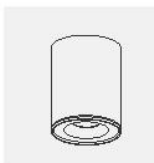

XD2127
P146

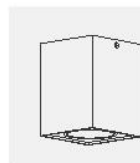

XD2128
P146

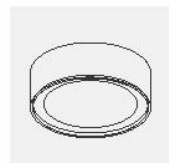

XD2131 / XD2187
XD2188
P122

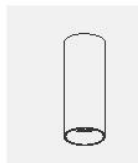

XD2135 / XD2136
P123



XD2139
P125

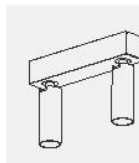

XD2142
P125

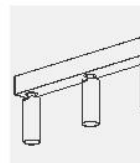

XD2143
P126

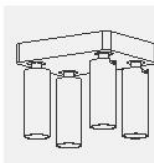

XD2144
P126



XD2145 / XD2145A
P130

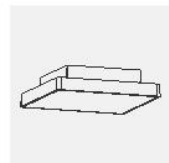

XD2150
P132

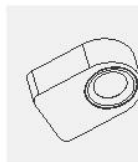

XD2151
P133

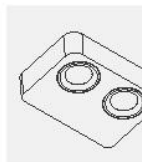

XD2152
P133



XD2153
P132



XD2155 / XD2155A
P131

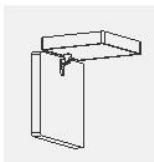

XD2157
P134



XD2158
P134

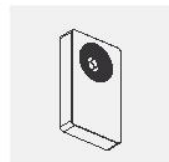

XD2165
P147



XD2196
P139

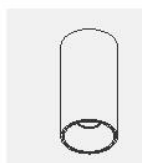

XD2197 / XD2198
XD2200
P135

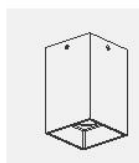

XD2199 / XD2201
XD2204
P136



XD2206 / XD2208
XD2207
P137



XD2211 / XD2212
P138

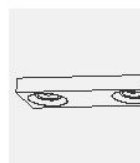

XD2217
P140



XD2218
P141

Index

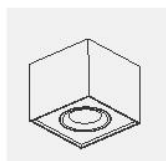

XD2224
P124

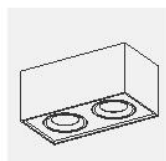

XD2224-2
P124

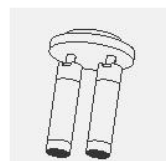

XD2228
P129



XD2229
P129



XD2230
P127

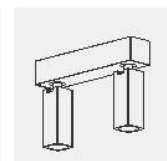

XD2231
P127

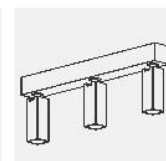

XD2232
P128

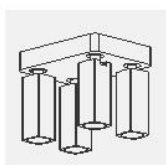

XD2233
P128

PENDANT LIGHT

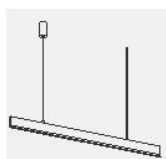

KF1027A
P149

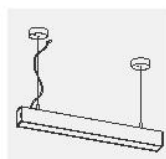

KF1028 / KF1029
P150



KF1030 / KF1031
P151

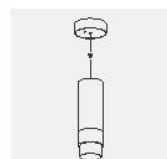

KF1059 / KF1060
P152

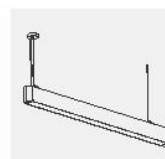

KF1084
P149

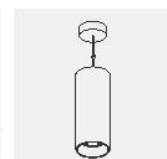

SL370 / SL371
P153



SL372 / SL373 / SL374
P154

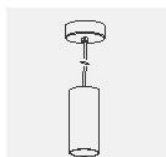

SL385 / SL385A
P155



SL386
P156



SL388
P158

Index

WALL LIGHT



WL396 / WL396A
P159



WL398A
P160

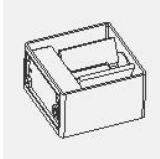

WL536
P160

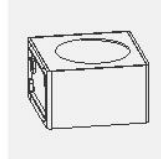

WL539
P161



WL541
P162

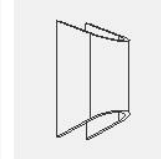

WL542
P162

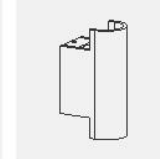

WL543
P163

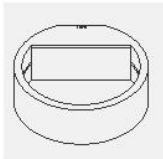

WL546
P163

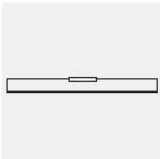

WL572
P164

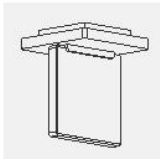

WL610
P157

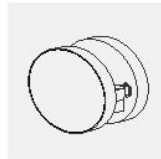

WL611
P165



WL612
P157



WL613
P165

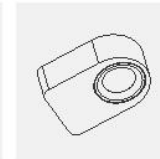

WL628
P158

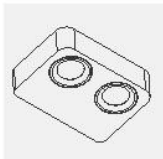

WL629
P158

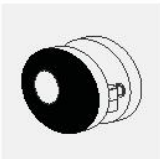

WL630
P164

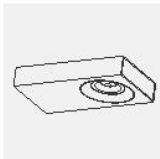

WL631
P166

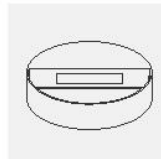

WL622
P167

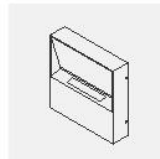

WL623
P167

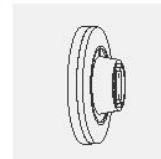

WL624
P168

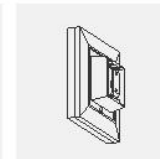

WL625
P168

OUTDOOR LIGHT



FL937 / FL937A
P173



KT568 / KT568A
P174

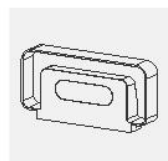

WL558
P176

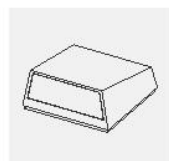

WL569
P175

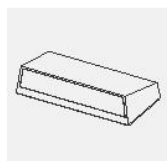

WL576
P175

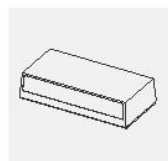

WL577
P176

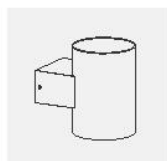

WL581 / WL582
WL583
P177

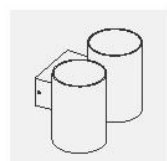

WL581A / WL582A
WL583A
P178

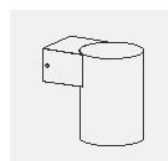

WL581B / WL582B
WL581C
P179



WL601 / WL602
WL603
P169

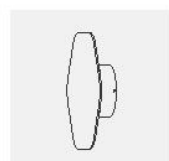

WL601A / WL602A
WL603A
P170

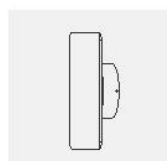

WL601B / WL602B
WL603B
P171

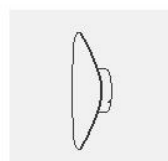

WL601C / WL602C
WL603C
P172

TRADITIONAL LIGHT

KT111E-1	P181	KT6001	P182	DL8140	P183	HKT8001-11	P184
KT111E-2	P181	KT6001S	P182	DL8141	P183	HKT8001	P184
KT111E-3	P181	KT6002	P182	DL8641	P183	KTK1-8001	P184
KT111E-4	P181	KT6002S	P182	HC8641	P183	KTW8001-11	P184
KT111E-4F	P181	KT6014	P182	DL8643	P183	KTW8001	P184
KT111H-1	P181	KT6015	P182	HC8643	P183	HKT8641	P184
KT111H-R	P181	KT6023T	P182	XD2024	P183	HKT8643	P184
KT111H-2A	P181	KT6382	P182	XD2025	P183	HKT122	P184
KT111H-3	P181	KT6394	P182	XD2065	P183	HKT123	P184
KT111H-3A	P181	KT6395	P182	XD2068	P183	MHT122	P184
KT111H-4F	P181	DL122	P182	XD2105	P183	MHT123	P184
KT12B-1	P181	HC122	P182				
KT12B-2	P181	DL8001	P182				
KT12B-3	P181	DL8061	P182				
KT12B-4F	P181	DL8126	P182				
KT16E-1	P181	DL8129	P182				
KT16E-2	P181	HC8129	P182				
KT16E-3	P181	DL8130	P182				
KT16E-4F	P181	HC8130	P182				

RECESSED DOWNLIGHT



OLSO FAMILY TILTABLE & ROTATABLE DOWNLIGHT

TECH. DRAWING

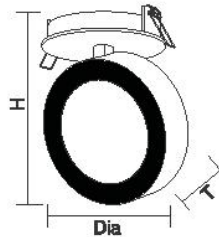

OLSO FAMILY

LED  AC 220-240 V IP20 ZMO

	W	LUM	CCT	BEAM	CRI	DIA	H	T	CUTOUT
KT6793	10	650	3000K	30°	80	Φ90mm	130mm	30mm	Φ98mm
KT6794	15	950	3000K	30°	80	Φ105mm	145mm	32mm	Φ98mm
KT6795	20	1200	3000K	30°	80	Φ120mm	160mm	33mm	Φ98mm

OPTIONS

Color RAL 9016 RAL 9006 RAL 9005
 Beam Angle 10° 20° 30°
 CCT 2700K 3000K 4000K
 CRI 80 90

SOURCE OPTION	LUMENS
DRIVER OPTION	/

REFERENCE DRAWING

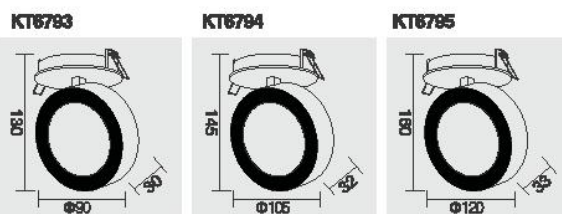

RECESSED DOWNLIGHT



ZOOMER FAMILY TILTABLE ZOOMER DOWNLIGHT

TECH. DRAWING

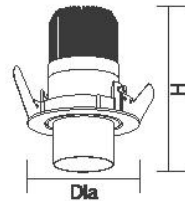

ZOOMER FAMILY

LED  100-240 V IP20 **KT6985** **Bridgelux** **KT6985-1** **CITIZEN** **AREEK**

	W	LUM	CCT	BEAM	CRI	DIA	H	CUTOUT
KT6985	15	360-530	3000K	8-45°	80	Ø96mm	135mm	Ø81mm
KT6985-1	30	1150-2250	3000K	18-55°	80	Ø110mm	139mm	Ø92mm

OPTIONS

Color RAL 9016 RAL 9006 RAL 9005

CCT 2700K 3000K 4000K

CRI 80 90

KT6985 SOURCE OPTION **CITIZEN**

KT6985-1 SOURCE OPTION **Bridgelux**

DRIVER OPTION **OSRAM / TCI / TRIDONIC / LIFUD**

REFERENCE DRAWING

KT6985

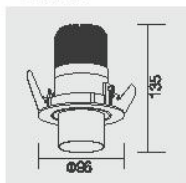

KT6985-1

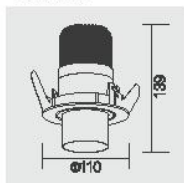

RECESSED DOWNLIGHT



LED 100-240 V IP20 CREE AREEK

	W	LUM	CCT	BEAM	CRI
KT8889	8	640	3000K	4°	80

EXTREM NARROW BEAM ANGLE TILTABLE RECESSED DOWNLIGHT

OPTIONS

Color RAL 9016 RAL 9006 RAL 9005

CCT 2700K 3000K 4000K

CRI 80 90

SOURCE OPTION /

DRIVER OPTION HEP / KEGU

TECH. DRAWING size in mm

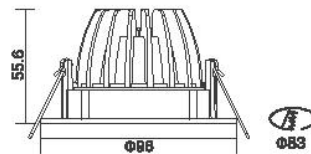

LED 100-240 V IP20 CITIZEN AREEK

	W	LUM	CCT	BEAM	CRI
KT8889A	12	994	3000K	25°	80

TILTABLE RECESSED DOWNLIGHT

OPTIONS

Color RAL 9016 RAL 9006 RAL 9005

Beam Angle 15° 25° 38° 60°

CCT 2700K 3000K 4000K

CRI 80 90

SOURCE OPTION Bridgelux

DRIVER OPTION TRIDONIC / HEP / LIFUD / KEGU

TECH. DRAWING size in mm

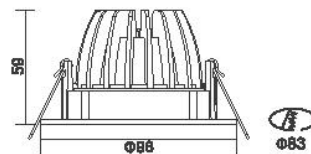

RECESSED DOWNLIGHT



LED 100-240 V IP20 CREE AREEK

	W	LUM	CCT	BEAM	CRI
KT8890	8	370	3000K	4°	80

EXTREM NARROW BEAM ANGLE TILTABLE & ROTATABLE DOWNLIGHT

OPTIONS

Color RAL 9016 RAL 9006 RAL 9005

CCT 2700K 3000K 4000K

CRI 80 90

SOURCE OPTION /

DRIVER OPTION HEP / KEGU

TECH. DRAWING size in mm

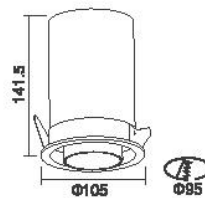

LED 100-240 V IP20 CITIZEN AREEK

	W	LUM	CCT	BEAM	CRI
KT8890A	12	994	3000K	25°	80

EXTREM NARROW BEAM ANGLE TILTABLE & ROTATABLE DOWNLIGHT

OPTIONS

Color RAL 9016 RAL 9006 RAL 9005

Beam Angle 15° 25° 38° 60°

CCT 2700K 3000K 4000K

CRI 80 90

SOURCE OPTION Bridgelux

DRIVER OPTION TRIDONIC / HEP / LIFUD / KEGU

TECH. DRAWING size in mm

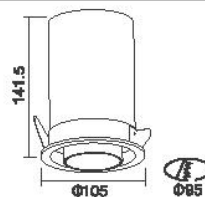

RECESSED DOWNLIGHT



LESS FAMILY TILTABLE RECESSED DOWNLIGHT

TECH. DRAWING

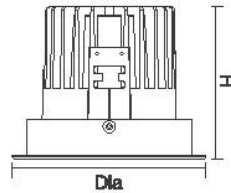

LESS FAMILY

LED  220-240 V IP20 CITIZEN OSRAM

	W	LUM	CCT	BEAM	CRI	DIA	H	CUTOUT
KT6855	20	1400	3000K	38°	80	Φ121mm	86mm	Φ117mm
KT6856	30	2100	3000K	30°	80	Φ131mm	93mm	Φ126mm

OPTIONS

- Color RAL 9016 RAL 9006 RAL 9005
- Beam Angle KT6855 15° 24° 38°
- Beam Angle KT6856 18° 30°
- CCT 2700K 3000K 4000K
- CRI 80 90

SOURCE OPTION

EVERCORE / Bridgelux

DRIVER OPTION

TRIDONIC / LIFUD / AREEK / KEGU

REFERENCE DRAWING

KT6855

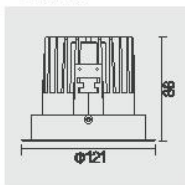

KT6856

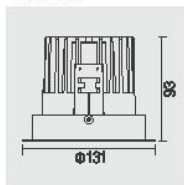

RECESSED DOWNLIGHT



LESS FAMILY FIXED RECESSED DOWNLIGHT

TECH. DRAWING

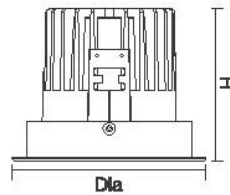

LESS FAMILY

LED 220-240 V IP20 CITIZEN OSRAM

	W	LUM	CCT	BEAM	CRI	DIA	H	CUTOUT
KT6857	20	1400	3000K	38°	80	Φ105mm	86mm	Φ93mm
KT6858	30	2100	3000K	30°	80	Φ115mm	93mm	Φ103mm

OPTIONS

- Color RAL 9016 RAL 9006 RAL 9005
- Beam Angle 15° 24° 38°
- Beam Angle 18° 30°
- CCT 2700K 3000K 4000K
- CRI 80 90

SOURCE OPTION

EVERCORE / Bridgelux

DRIVER OPTION

TRIDONIC / LIFUD / AREEK / KEGU

REFERENCE DRAWING

KT6857

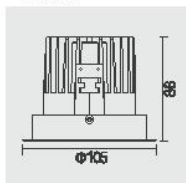

KT6858

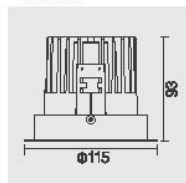

RECESSED DOWNLIGHT



LED  220-240 V IP20 CITIZEN KEGU

	W	LUM	CCT	BEAM	CRI
KT8867	8	800	3000K	38°	80

IBIS FAMILY - 360° GIMBAL

OPTIONS

Color	<input type="radio"/> RAL 9016	<input type="radio"/> RAL 9006	<input type="radio"/> RAL 9005	
Beam Angle	<input type="radio"/> 15°	<input type="radio"/> 25°	<input type="radio"/> 38°	<input type="radio"/> 60°
CCT	<input type="radio"/> 2700K	<input type="radio"/> 3000K	<input type="radio"/> 4000K	
CRI	<input type="radio"/> 80	<input type="radio"/> 90		

SOURCE OPTION **Bridgelux**

DRIVER OPTION **AREEK / AcTEC / HEP / TRIDONIC**

TECH. DRAWING size in mm

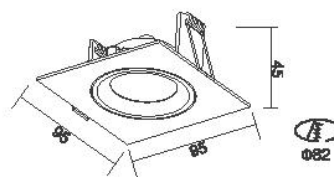

LED  220-240 V IP20 CITIZEN KEGU

	W	LUM	CCT	BEAM	CRI
KT8867-2	2x8	2x800	3000K	38°	80

IBIS FAMILY - 360° GIMBAL

OPTIONS

Color	<input type="radio"/> RAL 9016	<input type="radio"/> RAL 9006	<input type="radio"/> RAL 9005	
Beam Angle	<input type="radio"/> 15°	<input type="radio"/> 25°	<input type="radio"/> 38°	<input type="radio"/> 60°
CCT	<input type="radio"/> 2700K	<input type="radio"/> 3000K	<input type="radio"/> 4000K	
CRI	<input type="radio"/> 80	<input type="radio"/> 90		

SOURCE OPTION **Bridgelux**

DRIVER OPTION **AREEK / AcTEC / HEP / TRIDONIC**

TECH. DRAWING size in mm

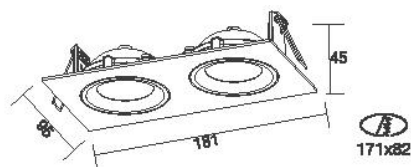

RECESSED DOWNLIGHT

IBIS FAMILY - 360° GIMBAL



OPTIONS

Color	<input type="radio"/> RAL 9016	<input type="radio"/> RAL 9006	<input type="radio"/> RAL 9005	
Beam Angle	<input type="radio"/> 15°	<input type="radio"/> 25°	<input type="radio"/> 38°	<input type="radio"/> 60°
CCT	<input type="radio"/> 2700K	<input type="radio"/> 3000K	<input type="radio"/> 4000K	
CRI	<input type="radio"/> 80	<input type="radio"/> 90		

SOURCE OPTION **Bridgelux**

DRIVER OPTION **AREEK / AcTEC / HEP / TRIDONIC**

LED  220-240 V IP20 CITIZEN KEGU

	W	LUM	CCT	BEAM	CRI
KT0915	8	800	3000K	38°	80

TECH. DRAWING size in mm

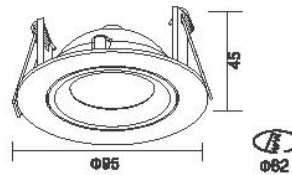

CUP FAMILY - FIXED DOWNLIGHT



OPTIONS

Color	<input type="radio"/> RAL 9016	<input type="radio"/> RAL 9006	<input type="radio"/> RAL 9005	
Beam Angle	<input type="radio"/> 15°	<input type="radio"/> 24°	<input type="radio"/> 38°	<input type="radio"/> 60°
CCT	<input type="radio"/> 2700K	<input type="radio"/> 3000K	<input type="radio"/> 4000K	
CRI	<input type="radio"/> 80	<input type="radio"/> 90		

SOURCE OPTION **Bridgelux**

DRIVER OPTION **TRIDONIC / KEGU / LIFUD**

LED  100-240 V IP20 EVERCORE AREEK

	W	LUM	CCT	BEAM	CRI
KT0913	8	660	3000K	24°	80

TECH. DRAWING size in mm

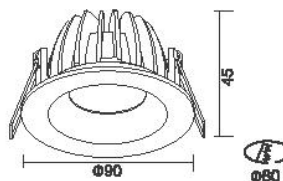

RECESSED DOWNLIGHT



LED  100-240 V IP20 EVERCORE AREEK

	W	LUM	CCT	BEAM	CRI
KT8814	8	660	3000K	24°	80

CUP FAMILY - TILTABLE DOWNLIGHT

OPTIONS

Color	<input type="radio"/> RAL 9016	<input type="radio"/> RAL 9006	<input type="radio"/> RAL 9005	
Beam Angle	<input type="radio"/> 15°	<input type="radio"/> 24°	<input type="radio"/> 38°	<input type="radio"/> 60°
CCT	<input type="radio"/> 2700K	<input type="radio"/> 3000K	<input type="radio"/> 4000K	
CRI	<input type="radio"/> 80	<input type="radio"/> 90		

SOURCE OPTION **Bridgelux**

DRIVER OPTION **TRIDONIC / KEQU / LIFUD**

TECH. DRAWING size in mm

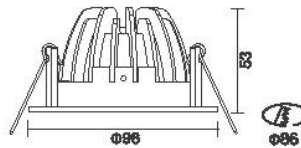

LED  100-240 V IP20 EVERCORE AREEK

	W	LUM	CCT	BEAM	CRI
KT8843	8	660	3000K	24°	80

CUP FAMILY - TILTABLE DOWNLIGHT

OPTIONS

Color	<input type="radio"/> RAL 9016	<input type="radio"/> RAL 9006	<input type="radio"/> RAL 9005	
Beam Angle	<input type="radio"/> 15°	<input type="radio"/> 24°	<input type="radio"/> 38°	<input type="radio"/> 60°
CCT	<input type="radio"/> 2700K	<input type="radio"/> 3000K	<input type="radio"/> 4000K	
CRI	<input type="radio"/> 80	<input type="radio"/> 90		

SOURCE OPTION **Bridgelux**

DRIVER OPTION **TRIDONIC / KEQU / LIFUD**

TECH. DRAWING size in mm

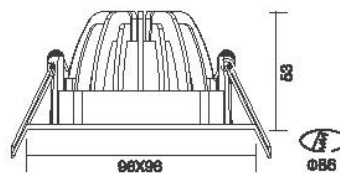

RECESSED DOWNLIGHT



LED  220-240 V IP20 CITIZEN KEGU

	W	LUM	CCT	BEAM	CRI
KT8826	16	1100	3000K	25°	80

BOWL FAMILY - TILTABLE & ROTATABLE

OPTIONS

Color RAL 9016 RAL 9006 RAL 9005
 Beam Angle 15° 25° 38° 60°
 CCT 2700K 3000K 4000K
 CRI 80 90

SOURCE OPTION **Bridgelux / EVERCORE**

DRIVER OPTION **AREEK / LIFUD / TRIDONIC**

TECH. DRAWING size in mm

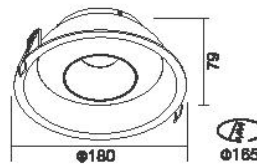

LED  220-240 V IP20 CITIZEN KEGU

	W	LUM	CCT	BEAM	CRI
KT8827	16	1050	3000K	25°	80

BOWL FAMILY - TILTABLE & ROTATABLE

OPTIONS

Color RAL 9016 RAL 9006 RAL 9005
 Beam Angle 15° 25° 38° 60°
 CCT 2700K 3000K 4000K
 CRI 80 90

SOURCE OPTION **Bridgelux / EVERCORE**

DRIVER OPTION **AREEK / LIFUD / TRIDONIC**

TECH. DRAWING size in mm

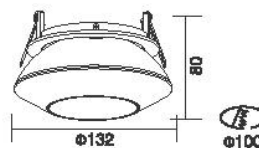

RECESSED DOWNLIGHT



PORTO FAMILY FIXED DOWNLIGHT

TECH. DRAWING

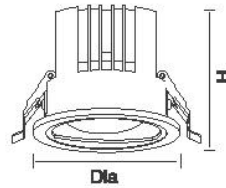

PORTO FAMILY

LED  220-240 V IP20 **Bridgelux** **OSRAM**

	W	LUM	CCT	BEAM	CRI	DIA	H	CUTOUT
KT6756	10	592	3000K	80°	80	Φ85mm	70mm	Φ75mm
KT6757	20	1212	3000K	80°	80	Φ107mm	85mm	Φ95mm
KT6758	36	2016	3000K	80°	80	Φ135mm	98mm	Φ115mm

OPTIONS

Color RAL 9016 RAL 9006 RAL 9005

CCT 2700K 3000K 4000K

CRI 80 90

SOURCE OPTION

CITIZEN

DRIVER OPTION

KEGU / AREEK / LIFUD

REFERENCE DRAWING

KT6756

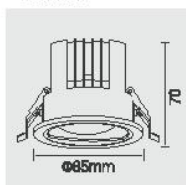

KT6757



KT6758



RECESSED DOWNLIGHT



HORN FAMILY FIXED DOWNLIGHT

TECH. DRAWING

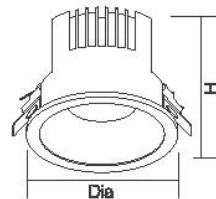

HORN FAMILY

LED 220-240 V IP20 Bridgelux OSRAM

	W	LUM	CCT	BEAM	CRI	DIA	H	CUTOUT
KT6756A	10	600	3000K	24°	80	Φ115mm	70mm	Φ77mm
KT6757A	20	1200	3000K	24°	80	Φ138mm	85mm	Φ93mm
KT6758A	36	2520	3000K	24°	80	Φ164mm	98mm	Φ115mm

OPTIONS

Color RAL 9016 RAL 9006 RAL 9005
 Beam Angle 12° 24° 36°
 CCT 2700K 3000K 4000K
 CRI 80 90

SOURCE OPTION

CITIZEN

DRIVER OPTION

KEGU / AREEK / LIFUD

REFERENCE DRAWING

KT6756A

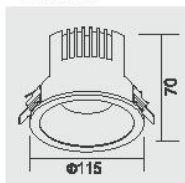

KT6757A

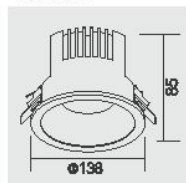

KT6758A

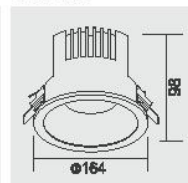

RECESSED DOWNLIGHT



HORN FAMILY TILTABLE DOWNLIGHT

TECH. DRAWING

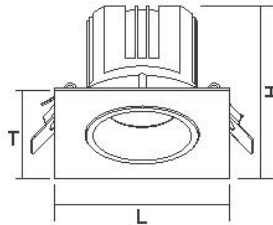

HORN FAMILY

LED 220-240 V IP20 **Bridgelux** **OSRAM**

	W	LUM	CCT	BEAM	CRI	LxT	H	CUTOUT
KT6756B	10	600	3000K	24°	80	115x115mm	70mm	Φ103mm
KT6757B	20	1200	3000K	24°	80	138x138mm	85mm	Φ128mm
KT6758B	36	2520	3000K	24°	80	164x164mm	98mm	Φ155mm

OPTIONS

- Color RAL 9016 RAL 9006 RAL 9005
 Beam Angle 12° 24° 36°
 CCT 2700K 3000K 4000K
 CRI 80 90

SOURCE OPTION

CITIZEN

DRIVER OPTION

KEGU / AREEK / LIFUD

REFERENCE DRAWING

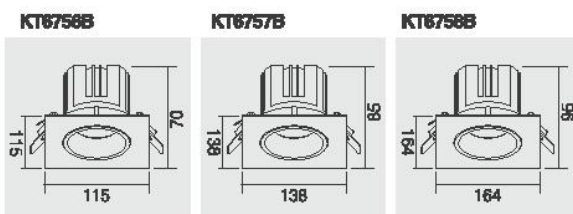

RECESSED DOWNLIGHT



HORN FAMILY TILTABLE DOWNLIGHT

TECH. DRAWING

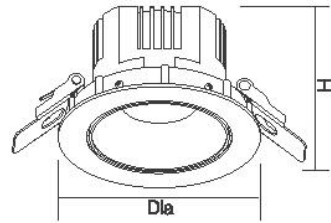

HORN FAMILY

LED 220-240 V IP20 Bridgelux OSRAM

	W	LUM	CCT	BEAM	CRI	DIA	H	CUTOUT
KT6756C	10	600	3000K	24°	80	Ø115mm	70mm	Ø103mm
KT6757C	20	1200	3000K	24°	80	Ø138mm	85mm	Ø128mm
KT6758C	36	2520	3000K	24°	80	Ø164mm	98mm	Ø155mm

OPTIONS

- Color RAL 9016 RAL 9006 RAL 9005
 Beam Angle 12° 24° 36°
 CCT 2700K 3000K 4000K
 CRI 80 90

SOURCE OPTION

CITIZEN

DRIVER OPTION

KEGU / AREEK / LIFUD

REFERENCE DRAWING

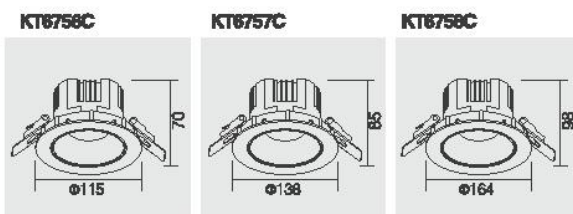

RECESSED DOWNLIGHT



ABRAS FAMILY- FIXED DOWNLIGHT

TECH. DRAWING

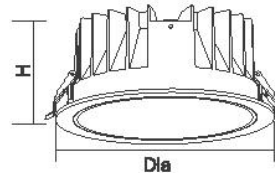

ABRAS FAMILY- FIXED DOWNLIGHT

LED 220-240 V IP20 CITIZEN OSRAM

	W	LUM	CCT	BEAM	CRI	DIA	H	CUTOUT
KT6759	11	506	3000K	80°	80	Φ115mm	66mm	Φ105mm
KT6761	22	1452	3000K	80°	80	Φ139mm	78mm	Φ125mm
KT6763	30	1620	3000K	80°	80	Φ160mm	85mm	Φ145mm
KT6765	40	2560	3000K	80°	80	Φ195mm	95mm	Φ180mm
KT6767	56	3416	3000K	80°	80	Φ230mm	100mm	Φ215mm

OPTIONS

Color RAL 9016 RAL 9006 RAL 9005

CCT 2700K 3000K 4000K

CRI 80 90

SOURCE OPTION

Bridgelux

DRIVER OPTION

KEGU / AREEK / LIFUD

REFERENCE DRAWING

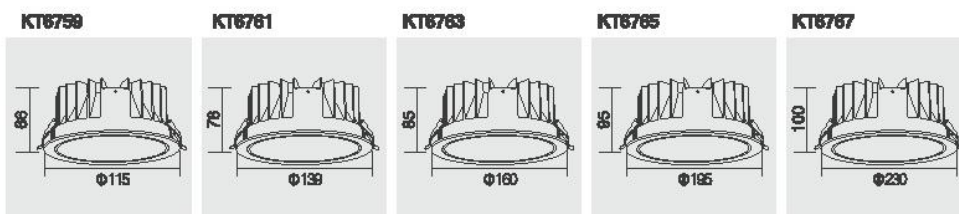

RECESSED DOWNLIGHT



HUZAR FAMILY- FIXED DOWNLIGHT

TECH. DRAWING

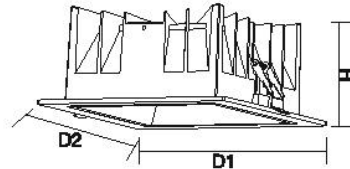

HUZAR FAMILY- FIXED DOWNLIGHT

LED 220-240 V IP20 CITIZEN OSRAM

	W	LUM	CCT	BEAM	CRI	LXT	H	CUTOUT
KT6760	11	770	3000K	80°	80	115x115mm	63mm	105x105mm
KT6762	22	1430	3000K	80°	80	140x140mm	75mm	125x125mm
KT6764	30	2220	3000K	80°	80	160x160mm	81mm	145x145mm
KT6766	40	2740	3000K	80°	80	195x195mm	96mm	170x170mm

OPTIONS

Color RAL 9016 RAL 9006 RAL 9005

CCT 2700K 3000K 4000K

CRI 80 90

SOURCE OPTION

BridgeLux

DRIVER OPTION

KEGU / AREEK / LIFUD

REFERENCE DRAWING

KT6760

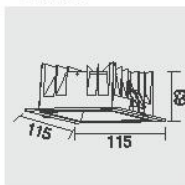

KT6762

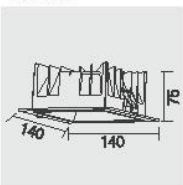

KT6764

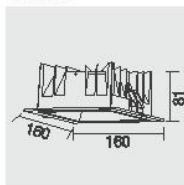

KT6766

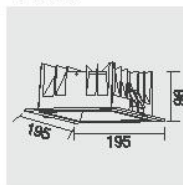

RECESSED DOWNLIGHT



IVORY FAMILY TILTABLE & ROTATABLE DOWNLIGHT

TECH. DRAWING

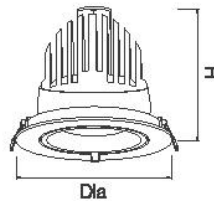

IVORY FAMILY

LED  220-240 V IP20 **Bridgelux** LIFUD

	W	LUM	CCT	BEAM	CRI	DIA	H	CUTOUT
KT6775	10	650	3000K	24°	80	Ø85mm	70mm	Ø75mm
KT6776	15	1125	3000K	24°	80	Ø115mm	90mm	Ø100mm
KT6777	25	2000	3000K	24°	80	Ø140mm	110mm	Ø128mm
KT6778	35	2625	3000K	60°	80	Ø165mm	130mm	Ø153mm
KT6779	45	3375	3000K	60°	80	Ø195mm	160mm	Ø175mm

OPTIONS

- Color RAL 9016 RAL 9006 RAL 9005
 Beam Angle 24° 45°
 Beam Angle 15° 24° 36° 60°
 CCT 2700K 3000K 4000K
 CRI 80 90

SOURCE OPTION

CITIZEN / EVERCORE

DRIVER OPTION

OSRAM / KEGU

PICTURES

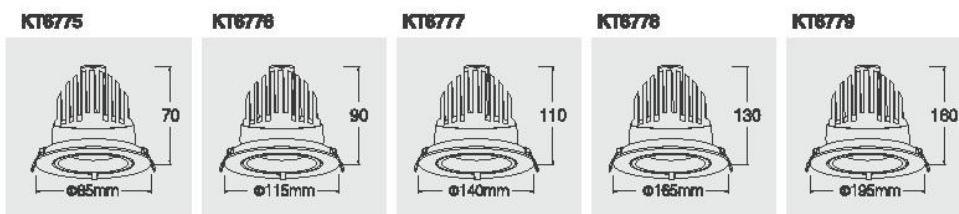

RECESSED DOWNLIGHT



LED  220-240 V IP20 CREE LIFUD

	W	LUM	CCT	BEAM	CRI
KT8781	10	500	3000K	15°	80

THUNDER FAMILY-TILTABLE

OPTIONS

Color	<input type="radio"/> RAL 9016	<input type="radio"/> RAL 9006	<input type="radio"/> RAL 9005
Beam Angle	<input type="radio"/> 15°	<input type="radio"/> 24°	<input type="radio"/> 38°
CCT	<input type="radio"/> 2700K	<input type="radio"/> 3000K	<input type="radio"/> 4000K
CRI	<input type="radio"/> 80	<input type="radio"/> 90	

SOURCE OPTION CITIZEN

DRIVER OPTION OSRAM / KEGU

TECH. DRAWING size in mm

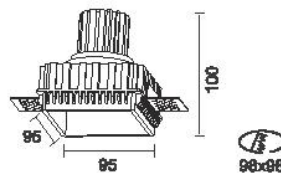

LED  220-240 V IP20 CREE LIFUD

	W	LUM	CCT	BEAM	CRI
KT8782	10	500	3000K	15°	80

THUNDER FAMILY-TILTABLE

OPTIONS

Color	<input type="radio"/> RAL 9016	<input type="radio"/> RAL 9006	<input type="radio"/> RAL 9005
Beam Angle	<input type="radio"/> 15°	<input type="radio"/> 24°	<input type="radio"/> 38°
CCT	<input type="radio"/> 2700K	<input type="radio"/> 3000K	<input type="radio"/> 4000K
CRI	<input type="radio"/> 80	<input type="radio"/> 90	

SOURCE OPTION CITIZEN

DRIVER OPTION OSRAM / KEGU

TECH. DRAWING size in mm

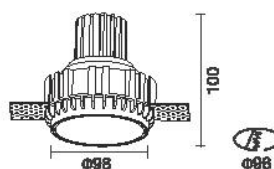

RECESSED DOWNLIGHT



LED  220-240 V IP20 Bridgelux LIFUD

	W	LUM	CCT	BEAM	CRI
KT8787	10	500	3000K	15°	80

CANEO FAMILY- TILTABLE

OPTIONS

Color	<input type="radio"/> RAL 9016	<input type="radio"/> RAL 9006	<input type="radio"/> RAL 9005
Beam Angle	<input type="radio"/> 15°	<input type="radio"/> 24°	<input type="radio"/> 38°
CCT	<input type="radio"/> 2700K	<input type="radio"/> 3000K	<input type="radio"/> 4000K
CRI	<input type="radio"/> 80	<input type="radio"/> 90	

SOURCE OPTION CITIZEN

DRIVER OPTION OSRAM / KEGU

TECH. DRAWING size in mm

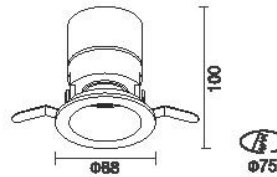

LED  220-240 V IP20 Bridgelux LIFUD

	W	LUM	CCT	BEAM	CRI
KT8788	10	500	3000K	15°	80

CANEO FAMILY- TILTABLE

OPTIONS

Color	<input type="radio"/> RAL 9016	<input type="radio"/> RAL 9006	<input type="radio"/> RAL 9005
Beam Angle	<input type="radio"/> 15°	<input type="radio"/> 24°	<input type="radio"/> 38°
CCT	<input type="radio"/> 2700K	<input type="radio"/> 3000K	<input type="radio"/> 4000K
CRI	<input type="radio"/> 80	<input type="radio"/> 90	

SOURCE OPTION CITIZEN

DRIVER OPTION OSRAM / KEGU

TECH. DRAWING size in mm

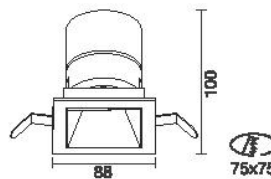

RECESSED DOWNLIGHT



LED  220-240 V IP20 Bridgelux LIFUD

	W	LUM	CCT	BEAM	CRI
KT8594	11	810	3000K	30°	80

RETROFIT DOWNLIGHTS FAMILY FIXED DOWNLIGHT

OPTIONS

Color RAL 9016 RAL 9006 RAL 9005
 Beam Angle 30° 60°
 CCT 2700K 3000K 4000K
 CRI 80 90

SOURCE OPTION **EVERCORE**

DRIVER OPTION **TRIDONIC / OSRAM / KEGU**

TECH. DRAWING size in mm

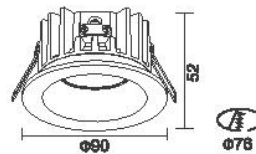

LED  220-240 V IP65 Bridgelux LIFUD

	W	LUM	CCT	BEAM	CRI
KT8594A	11	810	3000K	30°	80

RETROFIT DOWNLIGHTS FAMILY WATERPROOF FIXED DOWNLIGHT

OPTIONS

Color RAL 9016 RAL 9006 RAL 9005
 Beam Angle 30° 60°
 CCT 2700K 3000K 4000K
 CRI 80 90

SOURCE OPTION **EVERCORE**

DRIVER OPTIONS **TRIDONIC / OSRAM / KEGU**

TECH. DRAWING size in mm

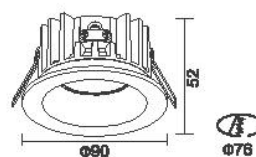

RECESSED DOWNLIGHT



LED  220-240 V IP20 Bridgelux LIFUD

	W	LUM	CCT	BEAM	CRI
KT8596	11	810	3000K	30°	80

RETROFIT DOWNLIGHTS FAMILY FIXED RECESSED DOWNLIGHT

OPTIONS

Color RAL 9016 RAL 9006 RAL 9005
 Beam Angle 30° 60°
 CCT 2700K 3000K 4000K
 CRI 80 90

SOURCE OPTION **EVERCORE**

DRIVER OPTION **TRIDONIC / OSRAM / KEGU**

TECH. DRAWING size in mm

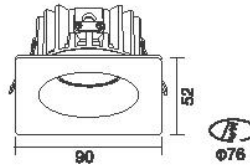

LED  220-240 V IP65 Bridgelux LIFUD

	W	LUM	CCT	BEAM	CRI
KT8586A	11	810	3000K	30°	80

RETROFIT DOWNLIGHTS FAMILY WATERPROOF FIXED DOWNLIGHT

OPTIONS

Color RAL 9016 RAL 9006 RAL 9005
 Beam Angle 30° 60°
 CCT 2700K 3000K 4000K
 CRI 80 90

SOURCE OPTION **EVERCORE**

DRIVER OPTION **TRIDONIC / OSRAM / KEGU**

TECH. DRAWING size in mm

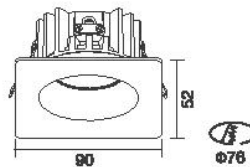

RECESSED DOWNLIGHT



MULTISQUARE FAMILY FIXED RECESSED DOWNLIGHT

OPTIONS

Color	<input type="radio"/> RAL 9016	<input type="radio"/> RAL 9006	<input type="radio"/> RAL 9005
Beam Angle	<input type="radio"/> 15°	<input type="radio"/> 24°	<input type="radio"/> 36°
CCT	<input type="radio"/> 2700K	<input type="radio"/> 3000K	<input type="radio"/> 4000K
CRI	<input type="radio"/> 80	<input type="radio"/> 90	

SOURCE OPTION OSRAM

DRIVER OPTION AREEK / LIFUD

LED  220-240 V IP20 Bridgelux KEGU

	W	LUM	CCT	BEAM	CRI
KT8867	12	1080	3000K	36°	80

TECH. DRAWING size in mm

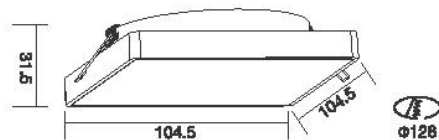

MULTISQUARE FAMILY FIXED RECESSED DOWNLIGHT

OPTIONS

Color	<input type="radio"/> RAL 9016	<input type="radio"/> RAL 9006	<input type="radio"/> RAL 9005
Beam Angle	<input type="radio"/> 15°	<input type="radio"/> 24°	<input type="radio"/> 36°
CCT	<input type="radio"/> 2700K	<input type="radio"/> 3000K	<input type="radio"/> 4000K
CRI	<input type="radio"/> 80	<input type="radio"/> 90	

SOURCE OPTION OSRAM

DRIVER OPTION AREEK / LIFUD

LED  220-240 V IP20 Bridgelux KEGU

	W	LUM	CCT	BEAM	CRI
KT8786	12	1080	3000K	36°	80

TECH. DRAWING size in mm

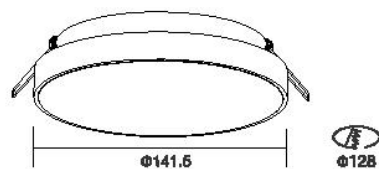

RECESSED DOWNLIGHT



LED  220-240 V IP20 Bridgelux KEGU

	W	LUM	CCT	BEAM	CRI
KT6644-1	8	640	3000K	35°	80

KT6644-1- TILTABLE & ROTATABLE

OPTIONS

Color RAL 9016 RAL 9006 RAL 9005

CCT 2700K 3000K 4000K

CRI 80 90

SOURCE OPTION CITIZEN / EVERCORE

DRIVER OPTION OSRAM / AREEK / LIFUD / HEP

TECH. DRAWING size in mm

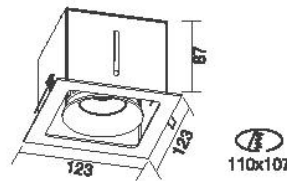

LED  220-240 V IP20 Bridgelux KEGU

	W	LUM	CCT	BEAM	CRI
KT6644-2	2x8	2x640	3000K	35°	80

KT6644-2- TILTABLE & ROTATABLE

OPTIONS

Color RAL 9016 RAL 9006 RAL 9005

CCT 2700K 3000K 4000K

CRI 80 90

SOURCE OPTION CITIZEN / EVERCORE

DRIVER OPTION OSRAM / AREEK / LIFUD / HEP

TECH. DRAWING size in mm

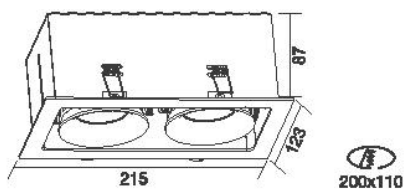

RECESSED DOWNLIGHT



LED  220-240 V IP20 Bridgelux KEGU

	W	LUM	CCT	BEAM	CRI
KT6644-3	3x8	3x640	3000K	35°	80

KT6644-3- TILTABLE & ROTATABLE

OPTIONS

Color RAL 9016 RAL 9006 RAL 9005

CCT 2700K 3000K 4000K

CRI 80 90

SOURCE OPTION CITIZEN / EVERCORE

DRIVER OPTION OSRAM / AREEK / LIFUD / HEP

TECH. DRAWING size in mm

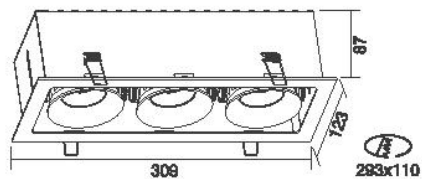

LED  220-240 V IP20 Bridgelux KEGU

	W	LUM	CCT	BEAM	CRI
KT6645-1	8	640	3000K	35°	80

KT6645-1- TILTABLE & ROTATABLE

OPTIONS

Color RAL 9016 RAL 9006 RAL 9005

CCT 2700K 3000K 4000K

CRI 80 90

SOURCE OPTION CITIZEN / EVERCORE

DRIVER OPTION OSRAM / AREEK / LIFUD / HEP

TECH. DRAWING size in mm

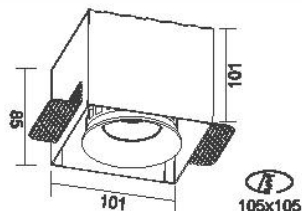

RECESSED DOWNLIGHT



LED  220-240 V IP20 Bridgelux KEGU

	W	LUM	CCT	BEAM	CRI
KT6645-2	2x8	2x640	3000K	35°	80

KT6645-2- TILTABLE & ROTATABLE

OPTIONS

Color RAL 9016 RAL 9006 RAL 9005

CCT 2700K 3000K 4000K

CRI 80 90

SOURCE OPTION CITIZEN / EVERCORE

DRIVER OPTION OSRAM / AREEK / LIFUD / HEP

TECH. DRAWING size in mm

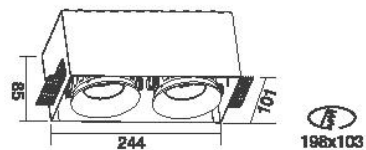

LED  220-240 V IP20 Bridgelux KEGU

	W	LUM	CCT	BEAM	CRI
KT6645-3	3x8	3x640	3000K	35°	80

KT6645-3- TILTABLE & ROTATABLE

OPTIONS

Color RAL 9016 RAL 9006 RAL 9005

CCT 2700K 3000K 4000K

CRI 80 90

SOURCE OPTION CITIZEN / EVERCORE

DRIVER OPTION OSRAM / AREEK / LIFUD / HEP

TECH. DRAWING size in mm

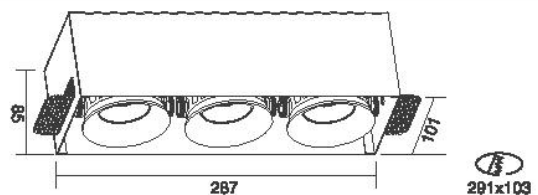

RECESSED DOWNLIGHT



KT6656 - FIXED DOWNLIGHT

OPTIONS

Color RAL 9016 RAL 9006 RAL 9005

CCT 2700K 3000K 4000K

CRI 80 90

SOURCE OPTION **CITIZEN / EVERCORE**

DRIVER OPTION **OSRAM / AREEK / LIFUD / HEP**

LED  220-240 V IP20 Bridgelux KEGU

	W	LUM	CCT	BEAM	CRI
KT6656	8	640	3000K	35°	80

TECH. DRAWING size in mm

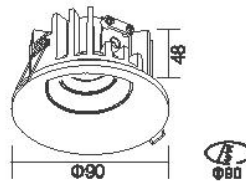

KT6657 - TILTABLE DOWNLIGHT

OPTIONS

Color RAL 9016 RAL 9006 RAL 9005

CCT 2700K 3000K 4000K

CRI 80 90

SOURCE OPTION **CITIZEN / EVERCORE**

DRIVER OPTION **OSRAM / AREEK / LIFUD / HEP**

LED  220-240 V IP20 Bridgelux KEGU

	W	LUM	CCT	BEAM	CRI
KT6657	8	640	3000K	35°	80

TECH. DRAWING size in mm

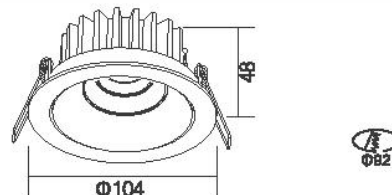

RECESSED DOWNLIGHT



LED  220-240 V IP20 Bridgelux KEGU

	W	LUM	CCT	BEAM	CRI
KT0659-1	8	640	3000K	30°	80

SARDINE FAMILY - TILTABLE

OPTIONS

Color	<input type="radio"/> RAL 9016	<input type="radio"/> RAL 9006	<input type="radio"/> RAL 9005
Beam Angle	<input type="radio"/> 30°	<input type="radio"/> 60°	
CCT	<input type="radio"/> 2700K	<input type="radio"/> 3000K	<input type="radio"/> 4000K
CRI	<input type="radio"/> 80	<input type="radio"/> 90	

SOURCE OPTION **EVERCORE**

DRIVER OPTION **LIFUD / TRIDONIC / OSRAM / AREEK**

TECH. DRAWING size in mm

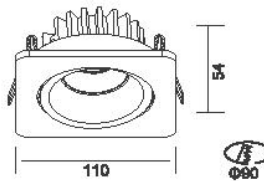

LED  220-240 V IP20 Bridgelux KEGU

	W	LUM	CCT	BEAM	CRI
KT0659-1	2x8	2x640	3000K	30°	80

SARDINE FAMILY - TILTABLE

OPTIONS

Color	<input type="radio"/> RAL 9016	<input type="radio"/> RAL 9006	<input type="radio"/> RAL 9005
Beam Angle	<input type="radio"/> 30°	<input type="radio"/> 60°	
CCT	<input type="radio"/> 2700K	<input type="radio"/> 3000K	<input type="radio"/> 4000K
CRI	<input type="radio"/> 80	<input type="radio"/> 90	

SOURCE OPTION **EVERCORE**

DRIVER OPTION **LIFUD / TRIDONIC / OSRAM / AREEK**

TECH. DRAWING size in mm

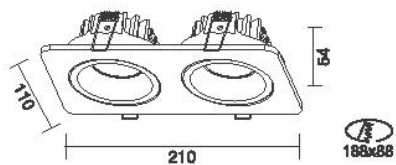

RECESSED DOWNLIGHT



LED  220-240 V IP20 CITIZEN OSRAM

	W	LUM	CCT	BEAM	CRI
KT8679-1	47	3400	3000K	36°	80

DRUM FAMILY- TILTABLE & ROTATABLE

OPTIONS

Color RAL 9016 RAL 9006 RAL 9005
 Beam Angle 13° 24° 36°
 CCT 2700K 3000K 4000K
 CRI 80 90

SOURCE OPTION /

DRIVER OPTION

AREEK / LIFUD

TECH. DRAWING size in mm

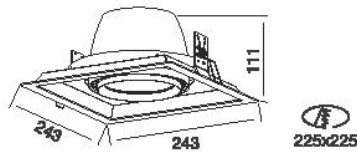

LED  220-240 V IP20 CITIZEN OSRAM

	W	LUM	CCT	BEAM	CRI
KT8679-2	2x47	2x3400	3000K	36°	80

DRUM FAMILY- TILTABLE & ROTATABLE

OPTIONS

Color RAL 9016 RAL 9006 RAL 9005
 Beam Angle 13° 24° 36°
 CCT 2700K 3000K 4000K
 CRI 80 90

SOURCE OPTION /

DRIVER OPTION

AREEK / LIFUD

TECH. DRAWING size in mm

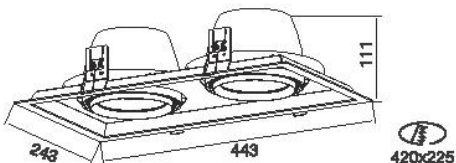

RECESSED DOWNLIGHT



LED  220-240 V IP20 CITIZEN KEGU

	W	LUM	CCT	BEAM	CRI
KT8896	40	3200	3000K	25°	80

CONE FAMILY - FIXED DOWNLIGHT

OPTIONS

Color RAL 9016 RAL 9006 RAL 9005

CCT 2700K 3000K 4000K

CRI 80 90

SOURCE OPTION OSRAM

DRIVER OPTION OSRAM / LIFUD / TRIDONIC / AREEK

TECH. DRAWING size in mm

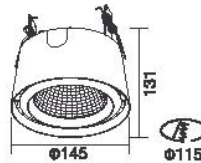

LED  220-240 V IP20 CITIZEN KEGU

	W	LUM	CCT	BEAM	CRI
KT8897	40	3200	3000K	25°	80

CONE FAMILY - FIXED DOWNLIGHT

OPTIONS

Color RAL 9016 RAL 9006 RAL 9005

CCT 2700K 3000K 4000K

CRI 80 90

SOURCE OPTION OSRAM

DRIVER OPTION OSRAM / LIFUD / TRIDONIC / AREEK

TECH. DRAWING size in mm

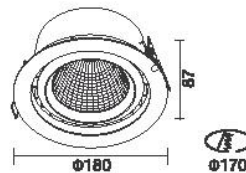

RECESSED DOWNLIGHT



CONE FAMILY - TILTABLE & ROTATABLE

OPTIONS

Color RAL 9016 RAL 9006 RAL 9005

CCT 2700K 3000K 4000K

CRI 80 90

SOURCE OPTION **OSRAM**

DRIVER OPTION **OSRAM / LIFUD / TRIDONIC / AREEK**

LED  220-240 V IP20 CITIZEN KEGU

	W	LUM	CCT	BEAM	CRI
KT6698	40	3200	3000K	25°	80

TECH. DRAWING size in mm

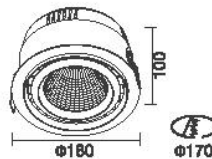

KT6830 - FIREPROOF DOWNLIGHT

OPTIONS

Color RAL 9016 RAL 9006 RAL 9005

CCT 2700K 3000K 4000K

CRI 80 90

SOURCE OPTION /

DRIVER OPTION /

LED  AC 220-240 V IP44 LUMENS

	W	LUM	CCT	BEAM	CRI
KT6830	8	570	3000K	26°	80

TECH. DRAWING size in mm

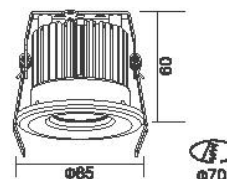

RECESSED DOWNLIGHT



LED  220-240 V IP20 CITIZEN OSRAM

	W	LUM	CCT	BEAM	CRI
KT8886	32	3000	3000K	38°	80

TAURUS FAMILY- TILTABLE & ROTATABLE

OPTIONS

Color	<input type="radio"/> RAL 9016	<input type="radio"/> RAL 9006	<input type="radio"/> RAL 9005	
Beam Angle	<input type="radio"/> 15°	<input type="radio"/> 24°	<input type="radio"/> 38°	<input type="radio"/> 55°
CCT	<input type="radio"/> 2700K	<input type="radio"/> 3000K	<input type="radio"/> 4000K	
CRI	<input type="radio"/> 80	<input type="radio"/> 90		

SOURCE OPTION **Bridgelux / TRIDONIC / EVERCORE**

DRIVER OPTION **TRIDONIC / KEGU / LIFUD**

TECH. DRAWING size in mm

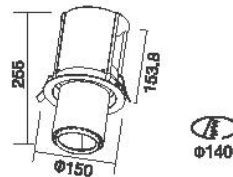

LED  220-240 V IP20 CITIZEN OSRAM

	W	LUM	CCT	BEAM	CRI
KT8887	32	3000	3000K	38°	80

TAURUS FAMILY- TILTABLE & ROTATABLE

OPTIONS

Color	<input type="radio"/> RAL 9016	<input type="radio"/> RAL 9006	<input type="radio"/> RAL 9005	
Beam Angle	<input type="radio"/> 15°	<input type="radio"/> 24°	<input type="radio"/> 38°	<input type="radio"/> 55°
CCT	<input type="radio"/> 2700K	<input type="radio"/> 3000K	<input type="radio"/> 4000K	
CRI	<input type="radio"/> 80	<input type="radio"/> 90		

SOURCE OPTION **Bridgelux / TRIDONIC / EVERCORE**

DRIVER OPTIONS **TRIDONIC / KEGU / LIFUD**

TECH. DRAWING size in mm

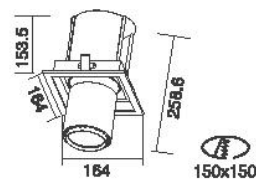

RECESSED DOWNLIGHT



TAURUS FAMILY- TILTABLE & ROTATABLE

OPTIONS

Color	<input type="radio"/> RAL 9016	<input type="radio"/> RAL 9006	<input type="radio"/> RAL 9005	
Beam Angle	<input type="radio"/> 15°	<input type="radio"/> 24°	<input type="radio"/> 38°	<input type="radio"/> 55°
CCT	<input type="radio"/> 2700K	<input type="radio"/> 3000K	<input type="radio"/> 4000K	
CRI	<input type="radio"/> 80	<input type="radio"/> 90		

SOURCE OPTION **Bridgelux / TRIDONIC / EVERCORE**

DRIVER OPTION **TRIDONIC / KEGU / LIFUD**

LED  220-240 V IP20 CITIZEN OSRAM

	W	LUM	CCT	BEAM	CRI
KT0908	2x32	2x3000	3000K	38°	80

TECH. DRAWING size in mm

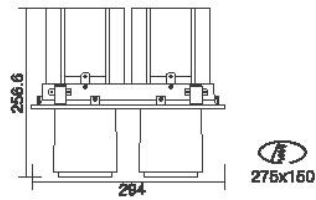

TRACK LIGHT



SMRITI FAMILY

For 3 phase track with integrated adapter driver

TECH. DRAWING

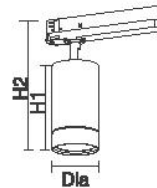

SMRITY FAMILY

LED 220-240 V IP20 CITIZEN PHILIPS

	W	LUM	CCT	BEAM	CRI	DIA	H1	H2
MHT8856	20	1611	3000K	40°	80	Ø81.5mm	116mm	203mm
MHT8857	32	2759	3000K	40°	80	Ø81.5mm	150.5mm	237.5mm
MHT8858	42	3774	3000K	40°	80	Ø81.5mm	195mm	282mm

OPTIONS

Color RAL 9016 RAL 9006 RAL 9005
 Beam Angle 15° 24° 40° 60°
 CCT 2700K 3000K 4000K
 CRI 80 90

SOURCE OPTION

OSRAM

ADAPTOR OPTION

GLOBAL / OSRAM

REFERENCE DRAWING

MHT8856

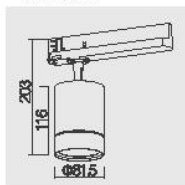

MHT8857

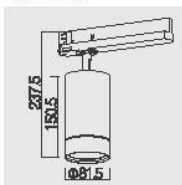

MHT8858

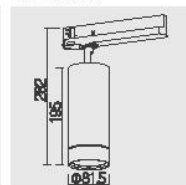

TRACK LIGHT



LED  220-240 V IP20 CREE AREEK

	W	LUM	CCT	BEAM	CRI
MI-T8867	3	110	3000K	8-25°	80

LESS FAMILY-ZOOMER

OPTIONS

Color RAL 9016 RAL 9006 RAL 9005

CCT 2700K 3000K 4000K

CRI 80 90

SOURCE OPTION /

DRIVER OPTION /

TECH. DRAWING size in mm

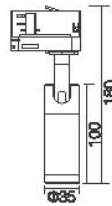

LED  220-240 V IP20 CREE AREEK

	W	LUM	CCT	BEAM	CRI
MI-T8863	3	116	3000K	20°	80

LESS FAMILY-TILTABLE & ROTATABLE

OPTIONS

Color RAL 9016 RAL 9006 RAL 9005

Beam Angle 20° 30° 40° 50° 60° 100°

CCT 2700K 3000K 4000K

CRI 80 90

SOURCE OPTION /

DRIVER OPTION /

TECH. DRAWING size in mm

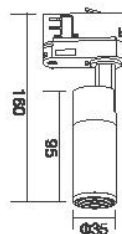

TRACK LIGHT



ASTREA LENS CHANGEABLE TRACK LIGHT

TECH. DRAWING

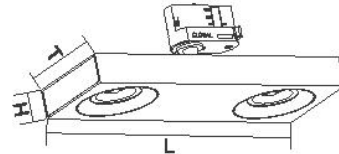

ASTREA FAMILY

LED  220-240 V  IP20  CITIZEN  OSRAM

	W	LUM	CCT	BEAM	CRI	L	T	H
MHT8871	2x15	500-1400	3000K	30°	80	280mm	100mm	30mm

OPTIONS

Color RAL 9016 RAL 9006 RAL 9005

CCT 2700K 3000K 4000K

CRI 80 90

SOURCE OPTION

OSRAM / Bridgelux

DRIVER OPTION

/

LENS OPTIONS

RONDA-WAS2-C



RONDA-WAS-C



RONDA-ZT45-C



RONDA-O-C



RONDA-WWC



RONDA-REC-60-C



RONDA-W-C



RONDA-WWC



RONDA-REC-C



RONDA-S-C



TRACK LIGHT



LED  220-240 V IP20 CITIZEN OSRAM

	W	LUM	CCT	BEAM	CRI
MI-T8882A - DALI	12	1020	3000K	40°	80

LESS FAMILY

For 3 phase track with DALI control

OPTIONS

Color RAL 9016 RAL 9006 RAL 9005
 Beam Angle 20° 40° 60°
 CCT 2700K 3000K 4000K
 CRI 80 90

SOURCE OPTION OSRAM / BRIDGELUX

DRIVER OPTION /

TECH. DRAWING size in mm

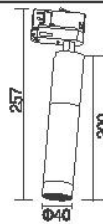

LED  220-240 V IP20 Bridgelux OSRAM

	W	LUM	CCT	BEAM	CRI
MI-T8882A	8	358	3000K	40°	80

LESS FAMILY- TILTABLE & ROTATABLE

OPTIONS

Color RAL 9016 RAL 9006 RAL 9005
 Beam Angle 20° 40° 60°
 CCT 2700K 3000K 4000K
 CRI 80 90

SOURCE OPTION /

DRIVER OPTION KEGU

TECH. DRAWING size in mm

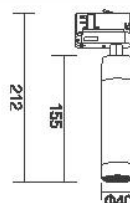

TRACK LIGHT



CAN FAMILY

For 3 phase track with integrated adapter driver

TECH. DRAWING

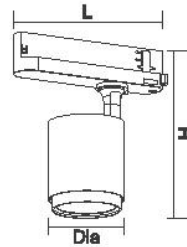

CAN FAMILY

LED 220-240 V IP20 OSRAM PHILIPS

	W	LUM	CCT	BEAM	CRI	DIA	H	L
MHT8874	15	1406	3000K	40°	80	Ø77.5mm	170.5mm	165mm
MHT8875	30	2714	3000K	40°	80	Ø89mm	179.5mm	220mm

OPTIONS

- Color RAL 9016 RAL 9006 RAL 9005
- Beam Angle 15° 24° 40°
- Beam Angle 16° 24° 40° 60°
- CCT 2700K 3000K 4000K
- CRI 80 90

SOURCE OPTION

EVERCORE / CITIZEN / Bridgelux

DRIVER OPTION

GLOBAL / OSRAM

REFERENCE DRAWING

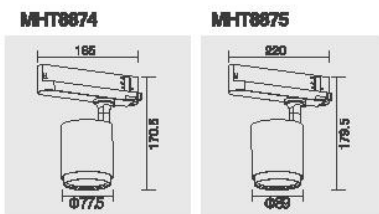



LESS FAMILY TILTABLE & ROTATABLE TRACK LIGHT

TECH. DRAWING

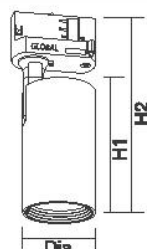

LESS FAMILY

LED 220-240 V IP20

	W	LUM	CCT	BEAM	CRI	SOURCE	DRIVER	DIA	H1	H2
MHT8877	30	3299	3000K	36°	80	ORSAM	ORSAM	Ø81mm	148mm	213mm
MHT8880	20	2042	3000K	38°	80	ORSAM	ORSAM	Ø76mm	145mm	211mm
MHT8881	12	887	3000K	36°	80	Bridgelux	KEGU	Ø60mm	109mm	175mm

OPTIONS

- Color RAL 9016 RAL 9006 RAL 9005
 Beam Angle 18° 24° 38°
 Beam Angle 15° 24° 36°
 CCT 2700K 3000K 4000K
 CRI 80 90

SOURCE OPTION

EVERCORE / Bridgelux / CITIZEN

DRIVER OPTION

HEP / AREEK / TRIDONIC

REFERENCE DRAWING

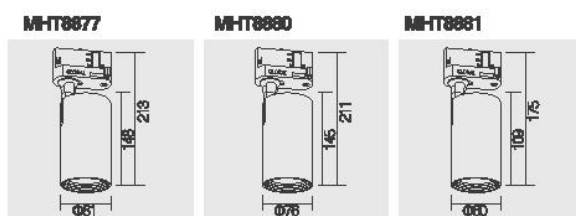

TRACK LIGHT



LESS FAMILY TILTABLE & ROTATABLE TRACK LIGHT

TECH. DRAWING

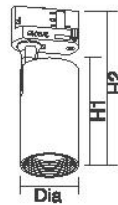

LESS FAMILY

LED  220-240 V IP20

	W	LUM	CCT	BEAM	CRI	SOURCE	DRIVER	DIA	H1	H2
MHT8877A	30	2902	3000K	40°	80	ORSAM	ORSAM	Ø81mm	175mm	241mm
MHT8880A	20	1901	3000K	40°	80	ORSAM	ORSAM	Ø76mm	165mm	213mm
MHT8881A	12	825	3000K	38°	80	Bridgelux	KEGU	Ø60mm	109mm	175mm

OPTIONS

Color RAL 9016 RAL 9006 RAL 9005
 Beam Angle 16° 24° 40° 60°
 Beam Angle 15° 24° 40°
 Beam Angle 15° 25° 38° 60°
 CCT 2700K 3000K 4000K
 CRI 80 90

SOURCE OPTION

Bridgelux / CITIZEN

DRIVER OPTION

TRIDONIC / AREEK

PICTURES

MHT8877A

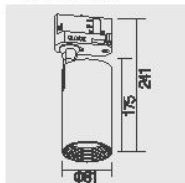

MHT8880A

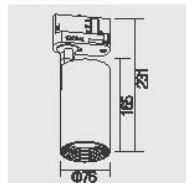

MHT8881A

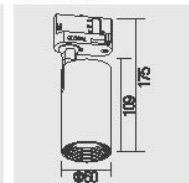



CAN FAMILY

For 3 phase track with integrated adapter driver

TECH. DRAWING

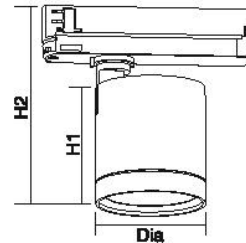

CAN FAMILY- GIMBAL TRACK LIGHT

LED 220-240 V IP20 Bridgelux PHILIPS

	W	LUM	CCT	BEAM	CRI	DIA	H1	H2
MHT8893	7	560	3000K	24°	80	Ø45mm	65mm	128mm
MHT8892	12	960	3000K	24°	80	Ø60mm	67mm	130mm
MHT8891	18	1440	3000K	24°	80	Ø70mm	77mm	140mm
MHT8890	30	2400	3000K	24°	80	Ø85mm	92mm	155mm

OPTIONS

Color RAL 9016 RAL 9006 RAL 9005
 Beam Angle 15° 24° 36° 60°
 Beam Angle 10° 15° 24° 36° 60°
 CCT 2700K 3000K 4000K
 CRI 80 90

SOURCE OPTION

CITIZEN

DRIVER OPTION

GLOBAL/OSRAM

REFERENCE DRAWING

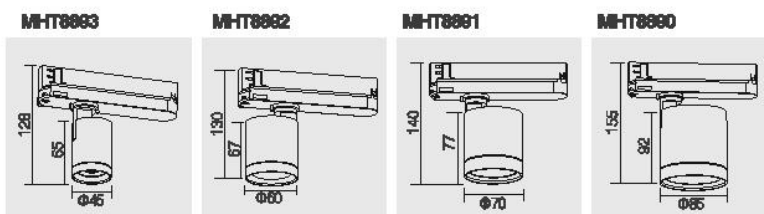

TRACK LIGHT



CAN FAMILY

For 3 phase track with integrated adapter driver

TECH. DRAWING

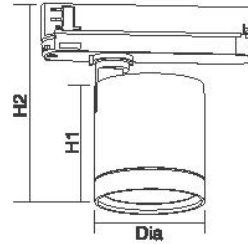

CAN FAMILY-GIMBAL TRACK LIGHT

LED 220-240 V IP20 Bridgelux PHILIPS

	W	LUM	CCT	BEAM	CRI	DIA	H1	H2
MHT8893A	7	560	3000K	20°	80	Ø45mm	65mm	128mm
MHT8892A	12	960	3000K	25°	80	Ø60mm	67mm	130mm
MHT8891A	18	1440	3000K	20°	80	Ø70mm	90mm	153mm
MHT8890A	30	2400	3000K	24°	80	Ø85mm	108mm	170mm

OPTIONS

- Color RAL 9016 RAL 9006 RAL 9005
- Beam Angle 20° 40° 60°
- Beam Angle 15° 25° 38° 60°
- Beam Angle 16° 24° 40° 60°
- CCT 2700K 3000K 4000K
- CRI 80 90

SOURCE OPTION

CITIZEN

DRIVER OPTION

GLOBAL / OSRAM

REFERENCE DRAWING

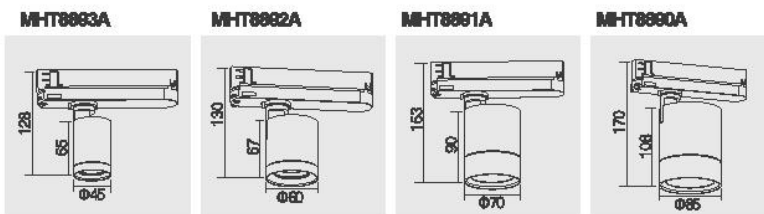

TRACK LIGHT



LED  220-240 V IP20 Bridgelux PHILIPS

	W	LUM	CCT	BEAM	CRI
MI-T8890B	20	1600	3000K	30°	80

CAN FAMILY

For 3 phase track with integrated adapter driver

OPTIONS

Color RAL 9016 RAL 9006 RAL 9005
 Beam Angle 10° 15° 25° 30°
 CCT 2700K 3000K 4000K
 CRI 80 90

SOURCE OPTION /

DRIVER OPTION GLOBAL / OSRAM

TECH. DRAWING size in mm

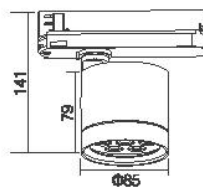

LED  220-240 V IP20 CREE PHILIPS

	W	LUM	CCT	BEAM	CRI
MI-T8891B	10	800	3000K	30°	80

CAN FAMILY

For 3 phase track with integrated adapter driver

OPTIONS

Color RAL 9016 RAL 9006 RAL 9005
 Beam Angle 10° 15° 25° 30°
 CCT 2700K 3000K 4000K
 CRI 80 90

SOURCE OPTION /

DRIVER OPTION GLOBAL / OSRAM

TECH. DRAWING size in mm

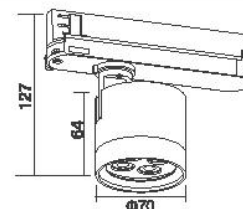

TRACK LIGHT



OLSO FAMILY TILTABLE & ROTATABLE TRACK LIGHT

TECH. DRAWING

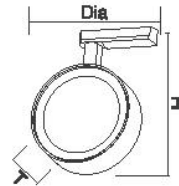

OLSO FAMILY

LED AC 220-240 V IP20 ZMO

	W	LUM	CCT	BEAM	CRI	DIA	H	T
KTK1 8834	10	650	3000K	30°	80	Φ90mm	125mm	30mm
KTK1 8835	15	950	3000K	30°	80	Φ105mm	140mm	32mm
KTK1 8836	20	1200	3000K	30°	80	Φ120mm	155mm	33mm

OPTIONS

Color RAL 9016 RAL 9006 RAL 9005
 Beam Angle 10° 20° 30°
 CCT 2700K 3000K 4000K
 CRI 80 90

SOURCE OPTION	LUMENS
DRIVER OPTION	/

REFERENCE DRAWING



TRACK LIGHT



MHT103-TILTABLE & ROTATABLE

OPTIONS

Color RAL 9016 RAL 9006 RAL 9005

CCT 2700K 3000K 4000K

CRI 80 90

SOURCE OPTION **EDISON**

DRIVER OPTION **OSRAM**

LED  220-240 V IP20 CREE PHILIPS

	W	LUM	CCT	BEAM	CRI
MHT103	40	3300	3000K	90°	80

TECH. DRAWING size in mm

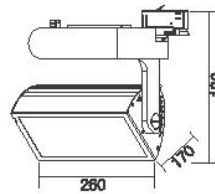

CONE FAMILY-TILTABLE & ROTATABLE

OPTIONS

Color RAL 9016 RAL 9006 RAL 9005

CCT 2700K 3000K 4000K

CRI 80 90

SOURCE OPTION /

DRIVER OPTION **AREEK / TRIDONIC / OSRAM**

LED  220-240 V IP20 CITIZEN LIFUD

	W	LUM	CCT	BEAM	CRI
MHT8583	40	3200	3000K	25°	80

TECH. DRAWING size in mm

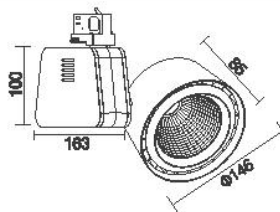

TRACK LIGHT



PIPE FAMILY TILTABLE & ROTATABLE TRACK LIGHT

TECH. DRAWING

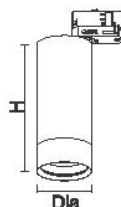

PIPE FAMILY

LED  AC 220-240 V IP20 LUMENS

	W	LUM	CCT	BEAM	CRI	DIA	H
MHT8596A	20	1500	3000K	38°	80	Φ76mm	185mm
MHT8596B	30	2200	3000K	38°	80	Φ76mm	200mm
MHT8597	40	3000	3000K	40°	80	Φ86mm	220mm

OPTIONS

Color RAL 9016 RAL 9006 RAL 9005

CCT 2700K 3000K 4000K

CRI 80 90

SOURCE OPTION

EDISON

DRIVER OPTION

/

REFERENCE DRAWING

MHT8596A

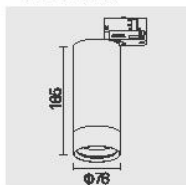

MHT8596B

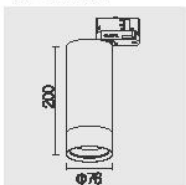

MHT8597

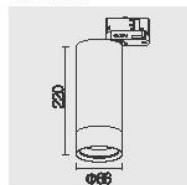

TRACK LIGHT



LESS FAMILY TILTABLE & ROTATABLE TRACK LIGHT

TECH. DRAWING

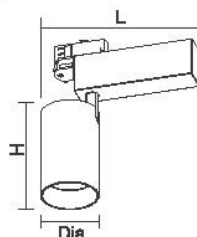

LESS FAMILY

LED  220-240 V IP20 CITIZEN OSRAM

	W	LUM	CCT	BEAM	CRI	DIA	H	L
MHT8830	20	1400	3000K	38°	80	Ø76mm	213mm	197mm
MHT8831	30	2100	3000K	30°	80	Ø89mm	223mm	211mm

OPTIONS

Color RAL 9016 RAL 9006 RAL 9005

Beam Angle 15° 24° 38°

Beam Angle 18° 30°

CCT 2700K 3000K 4000K

CRI 80 90

SOURCE OPTION

EVERCORE / Bridgelux

DRIVER OPTION

TRIDONIC / LIFUD / AREEK

REFERENCE DRAWING

MHT8830

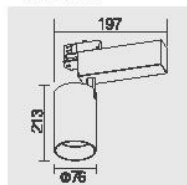

MHT8831

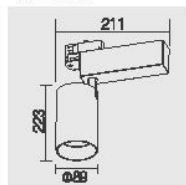

TRACK LIGHT



ZOOMER FAMILY TILTABLE & ROTATABLE ZOOMER TRACK LIGHT

TECH. DRAWING

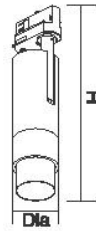

ZOOMER FAMILY

LED  100-240 V IP20 MHT8837 **Bridgelux** MHT8847 **CITIZEN** **AREEK**

	W	LUM	CCT	BEAM	CRI	DIA	H
MHT8837	15	360-530	3000K	8-45°	80	Ø60mm	261mm
MHT8847	30	1150-2250	3000K	18-55°	80	Ø76mm	305mm

OPTIONS

Color RAL 9016 RAL 9006 RAL 9005

CCT 2700K 3000K 4000K

CRI 80 90

MHT8837 SOURCE OPTION

OSRAM

MHT8847 SOURCE OPTION

Bridgelux

DRIVER OPTION

OSRAM / TRIDONIC / TCI

REFERENCE DRAWING

MHT8837

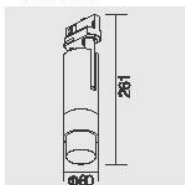

MHT8847

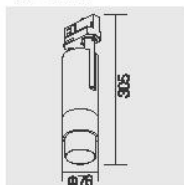

TRACK LIGHT



EXTREM NARROW BEAM ANGLE TILTABLE & ROTATABLE TRACK LIGHT

OPTIONS

Color RAL 9016 RAL 9006 RAL 9005

CCT 2700K 3000K 4000K

CRI 80 90

SOURCE OPTION

/

DRIVER OPTION

HEP / KEGU

LED 100-240 V IP20 CREE AREEK

	W	LUM	CCT	BEAM	CRI
MI-T8841	8	509	3000K	4°	80

TECH. DRAWING size in mm



EXTREM NARROW BEAM ANGLE TILTABLE & ROTATABLE TRACK LIGHT

OPTIONS

Color RAL 9016 RAL 9006 RAL 9005

Beam Angle 15° 25° 38° 60°

CCT 2700K 3000K 4000K

CRI 80 90

SOURCE OPTION

Bridgelux

DRIVER OPTION

TRIDONIC / HEP

LED 100-240 V IP20 CITIZEN AREEK

	W	LUM	CCT	BEAM	CRI
MI-T8841A	12	913	3000K	25°	80

TECH. DRAWING size in mm

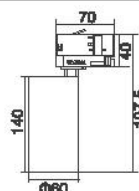

TRACK LIGHT



LED  220-240 V IP20 Bridgelux GLOBAL

	W	LUM	CCT	BEAM	CRI
MI-T8846	12	1080	3000K	36°	80

MULTIS SQUARE FAMILY

For 3 phase track with integrated adapter driver

OPTIONS

Color	<input type="radio"/> RAL 9016	<input type="radio"/> RAL 9006	<input type="radio"/> RAL 9005
Beam Angle	<input type="radio"/> 15°	<input type="radio"/> 24°	<input type="radio"/> 36°
CCT	<input type="radio"/> 2700K	<input type="radio"/> 3000K	<input type="radio"/> 4000K
CRI	<input type="radio"/> 80	<input type="radio"/> 90	

SOURCE OPTION OSRAM

DRIVER OPTION PHILIPS / OSRAM

TECH. DRAWING size in mm

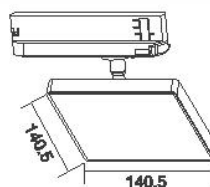

LED  220-240 V IP20 Bridgelux GLOBAL

	W	LUM	CCT	BEAM	CRI
MI-T8846	12	1080	3000K	36°	80

MULTIS ROUND FAMILY

For 3 phase track with integrated adapter driver

OPTIONS

Color	<input type="radio"/> RAL 9016	<input type="radio"/> RAL 9006	<input type="radio"/> RAL 9005
Beam Angle	<input type="radio"/> 15°	<input type="radio"/> 24°	<input type="radio"/> 36°
CCT	<input type="radio"/> 2700K	<input type="radio"/> 3000K	<input type="radio"/> 4000K
CRI	<input type="radio"/> 80	<input type="radio"/> 90	

SOURCE OPTION OSRAM

DRIVER OPTION PHILIPS / OSRAM

TECH. DRAWING size in mm

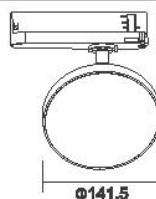

TRACK LIGHT



TAURUS FAMILY

For 3 phase track with integrated adapter driver

OPTIONS

Color	<input type="radio"/> RAL 9016	<input type="radio"/> RAL 9006	<input type="radio"/> RAL 9005
Beam Angle	<input type="radio"/> 15°	<input type="radio"/> 24°	<input type="radio"/> 38° <input type="radio"/> 55°
CCT	<input type="radio"/> 2700K	<input type="radio"/> 3000K	<input type="radio"/> 4000K
CRI	<input type="radio"/> 80	<input type="radio"/> 90	

SOURCE OPTION OSRAM / CITIZEN / EVERCORE

DRIVER OPTION PHILIPS / OSRAM

LED  220-240 V IP20 Bridgelux GLOBAL

	W	LUM	CCT	BEAM	CRI
MHT8672	32	3000	3000K	38°	80

TECH. DRAWING size in mm

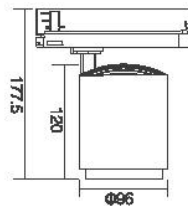

DRUM

TILTABLE & ROTATABLE TRACK LIGHT

OPTIONS

Color	<input type="radio"/> RAL 9016	<input type="radio"/> RAL 9006	<input type="radio"/> RAL 9005
Beam Angle	<input type="radio"/> 13°	<input type="radio"/> 24°	<input type="radio"/> 36°
CCT	<input type="radio"/> 2700K	<input type="radio"/> 3000K	<input type="radio"/> 4000K
CRI	<input type="radio"/> 80	<input type="radio"/> 90	

SOURCE OPTION /

DRIVER OPTION LIFUD / AREEK

LED  220-240 V IP20 CITIZEN OSRAM

	W	LUM	CCT	BEAM	CRI
MHT8575	47	3400	3000K	36°	80

TECH. DRAWING size in mm

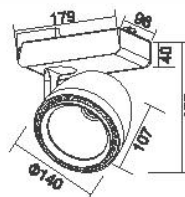

SURFACE MOUNTED LIGHT



LED  220-240 V IP20 CITIZEN KEGU

	W	LUM	CCT	BEAM	CRI
XD2077-1	16	1050	3000K	25°	80

BOWL FAMILY - TILTABLE & ROTATABLE

OPTIONS

Color	<input type="radio"/> RAL 9016	<input type="radio"/> RAL 9006	<input type="radio"/> RAL 9005	
Beam Angle	<input type="radio"/> 15°	<input type="radio"/> 25°	<input type="radio"/> 38°	<input type="radio"/> 60°
CCT	<input type="radio"/> 2700K	<input type="radio"/> 3000K	<input type="radio"/> 4000K	
CRI	<input type="radio"/> 80	<input type="radio"/> 90		

SOURCE OPTION **Brigelux**

DRIVER OPTION **AREEK / LIFUD / TRIDONIC**

TECH. DRAWING size in mm

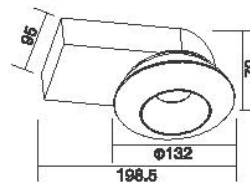

LED  220-240 V IP20 CITIZEN KEGU

	W	LUM	CCT	BEAM	CRI
XD2077-2	2x16	2x1050	3000K	25°	80

BOWL FAMILY - TILTABLE & ROTATABLE

OPTIONS

Color	<input type="radio"/> RAL 9016	<input type="radio"/> RAL 9006	<input type="radio"/> RAL 9005	
Beam Angle	<input type="radio"/> 15°	<input type="radio"/> 25°	<input type="radio"/> 38°	<input type="radio"/> 60°
CCT	<input type="radio"/> 2700K	<input type="radio"/> 3000K	<input type="radio"/> 4000K	
CRI	<input type="radio"/> 80	<input type="radio"/> 90		

SOURCE OPTION **Brigelux**

DRIVER OPTION **AREEK / LIFUD / TRIDONIC**

TECH. DRAWING size in mm

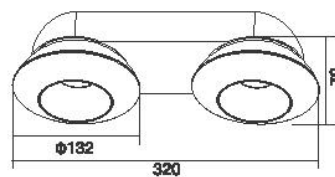

SURFACE MOUNTED LIGHT



OLSO FAMILY FIXED CEILING LIGHT

TECH. DRAWING

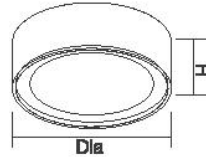

OLSO FAMILY

LED  AC 220-240 V  IP20  ZMO

	W	LUM	CCT	BEAM	CRI	DIA	H
XD2131	10	650	3000K	30°	80	Φ90mm	30mm
XD2187	15	950	3000K	30°	80	Φ105mm	32mm
XD2188	20	1200	3000K	30°	80	Φ120mm	33mm

OPTIONS

Color RAL 9016 RAL 9006 RAL 9005
 Beam Angle 10° 20° 30°
 CCT 2700K 3000K 4000K
 CRI 80 90

SOURCE OPTION	LUMENS
DRIVER OPTION	/

REFERENCE DRAWING

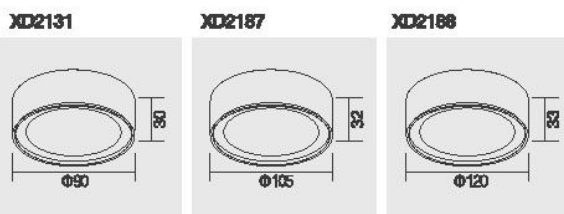

SURFACE MOUNTED LIGHT



LESS FAMILY FIXED CEILING LIGHT

TECH. DRAWING



LESS FAMILY

LED 220-240 V IP20 CITIZEN OSRAM

	W	LUM	CCT	BEAM	CRI	DIA	H
XD2135	20	1400	3000K	38°	80	Ø76mm	190mm
XD2136	30	2100	3000K	30°	80	Ø89mm	210mm

OPTIONS

- Color RAL 9016 RAL 9006 RAL 9005
- Beam Angle 15° 24° 36°
- Beam Angle 18° 30°
- CCT 2700K 3000K 4000K
- CRI 80 90

SOURCE OPTION

EVERCORE / Bridgelux

DRIVER OPTION

TRIDONIC / LIFUD / AREEK

REFERENCE DRAWING

XD2135

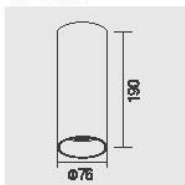

XD2136

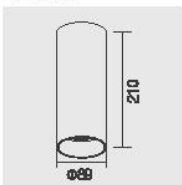

SURFACE MOUNTED LIGHT



IBIS FAMILY - 360° GIMBAL

OPTIONS

Color	<input type="radio"/> RAL 9016	<input type="radio"/> RAL 9006	<input type="radio"/> RAL 9005	
Beam Angle	<input type="radio"/> 15°	<input type="radio"/> 25°	<input type="radio"/> 38°	<input type="radio"/> 60°
CCT	<input type="radio"/> 2700K	<input type="radio"/> 3000K	<input type="radio"/> 4000K	
CRI	<input type="radio"/> 80	<input type="radio"/> 90		

SOURCE OPTION Bridgelux / EVERCORE

DRIVER OPTION AREEK / AcTEC / KEGU

LED  220-240 V IP20 CITIZEN HEP

	W	LUM	CCT	BEAM	CRI
XD2224	8	800	3000K	38°	80

TECH. DRAWING size in mm

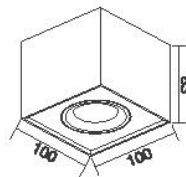

IBIS FAMILY - 360° GIMBAL

OPTIONS

Color	<input type="radio"/> RAL 9016	<input type="radio"/> RAL 9006	<input type="radio"/> RAL 9005	
Beam Angle	<input type="radio"/> 15°	<input type="radio"/> 25°	<input type="radio"/> 38°	<input type="radio"/> 60°
CCT	<input type="radio"/> 2700K	<input type="radio"/> 3000K	<input type="radio"/> 4000K	
CRI	<input type="radio"/> 80	<input type="radio"/> 90		

SOURCE OPTION Bridgelux / EVERCORE

DRIVER OPTION AREEK / AcTEC / KEGU

LED  220-240 V IP20 CITIZEN HEP

	W	LUM	CCT	BEAM	CRI
XD2224-2	2x8	2x800	3000K	38°	80

TECH. DRAWING size in mm

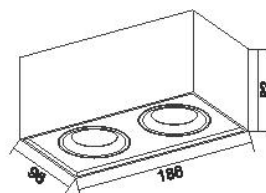

SURFACE MOUNTED LIGHT



LED  100-240 V IP20 Bridgelux AREEK

	W	LUM	CCT	BEAM	CRI
XD2139	8	550	3000K	20°	80

ROBOT FAMILY- TILTABLE & ROTATABLE

OPTIONS

Color	<input type="radio"/> RAL 9016	<input type="radio"/> RAL 9006	<input type="radio"/> RAL 9005
Beam Angle	<input type="radio"/> 20°	<input type="radio"/> 40°	<input type="radio"/> 60°
CCT	<input type="radio"/> 2700K	<input type="radio"/> 3000K	<input type="radio"/> 4000K
CRI	<input type="radio"/> 80	<input type="radio"/> 90	

SOURCE OPTION EVERCORE

DRIVER OPTION TRIDONIC / OSRAM / KEGU

TECH. DRAWING size in mm

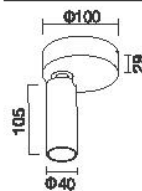

LED  100-240 V IP20 Bridgelux AREEK

	W	LUM	CCT	BEAM	CRI
XD2142	2x8	2x550	3000K	20°	80

ROBOT FAMILY- TILTABLE & ROTATABLE

OPTIONS

Color	<input type="radio"/> RAL 9016	<input type="radio"/> RAL 9006	<input type="radio"/> RAL 9005
Beam Angle	<input type="radio"/> 20°	<input type="radio"/> 40°	<input type="radio"/> 60°
CCT	<input type="radio"/> 2700K	<input type="radio"/> 3000K	<input type="radio"/> 4000K
CRI	<input type="radio"/> 80	<input type="radio"/> 90	

SOURCE OPTION EVERCORE

DRIVER OPTION TRIDONIC / OSRAM / KEGU

TECH. DRAWING size in mm

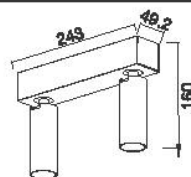

SURFACE MOUNTED LIGHT



LED  100-240 V IP20 Bridgelux AREEK

	W	LUM	CCT	BEAM	CRI
XD2143	3x8	3x550	3000K	20°	80

ROBOT FAMILY- TILTABLE & ROTATABLE

OPTIONS

Color	<input type="radio"/> RAL 9016	<input type="radio"/> RAL 9006	<input type="radio"/> RAL 9005
Beam Angle	<input type="radio"/> 20°	<input type="radio"/> 40°	<input type="radio"/> 60°
CCT	<input type="radio"/> 2700K	<input type="radio"/> 3000K	<input type="radio"/> 4000K
CRI	<input type="radio"/> 80	<input type="radio"/> 90	

SOURCE OPTION **EVERCORE**

DRIVER OPTION **TRIDONIC / OSRAM / KEGU**

TECH. DRAWING size in mm

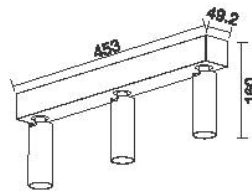

LED  100-240 V IP20 Bridgelux AREEK

	W	LUM	CCT	BEAM	CRI
XD2144	4x8	4x550	3000K	20°	80

ROBOT FAMILY- TILTABLE & ROTATABLE

OPTIONS

Color	<input type="radio"/> RAL 9016	<input type="radio"/> RAL 9006	<input type="radio"/> RAL 9005
Beam Angle	<input type="radio"/> 20°	<input type="radio"/> 40°	<input type="radio"/> 60°
CCT	<input type="radio"/> 2700K	<input type="radio"/> 3000K	<input type="radio"/> 4000K
CRI	<input type="radio"/> 80	<input type="radio"/> 90	

SOURCE OPTION **EVERCORE**

DRIVER OPTION **TRIDONIC / OSRAM / KEGU**

TECH. DRAWING size in mm

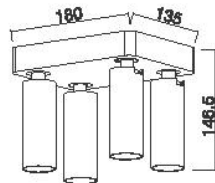

SURFACE MOUNTED LIGHT



LED  100-240 V IP20 Bridgelux AREEK

	W	LUM	CCT	BEAM	CRI
XD2230	8	550	3000K	20°	80

ROBOT FAMILY- TILTABLE & ROTATABLE

OPTIONS

Color	<input type="radio"/> RAL 9016	<input type="radio"/> RAL 9006	<input type="radio"/> RAL 9005
Beam Angle	<input type="radio"/> 20°	<input type="radio"/> 40°	<input type="radio"/> 60°
CCT	<input type="radio"/> 2700K	<input type="radio"/> 3000K	<input type="radio"/> 4000K
CRI	<input type="radio"/> 80	<input type="radio"/> 90	

SOURCE OPTION **EVERCORE**

DRIVER OPTION **TRIDONIC / OSRAM / KEGU**

TECH. DRAWING size in mm

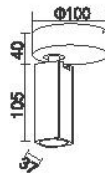

LED  100-240 V IP20 Bridgelux AREEK

	W	LUM	CCT	BEAM	CRI
XD2231	2x8	2x550	3000K	20°	80

ROBOT FAMILY- TILTABLE & ROTATABLE

OPTIONS

Color	<input type="radio"/> RAL 9016	<input type="radio"/> RAL 9006	<input type="radio"/> RAL 9005
Beam Angle	<input type="radio"/> 20°	<input type="radio"/> 40°	<input type="radio"/> 60°
CCT	<input type="radio"/> 2700K	<input type="radio"/> 3000K	<input type="radio"/> 4000K
CRI	<input type="radio"/> 80	<input type="radio"/> 90	

SOURCE OPTION **EVERCORE**

DRIVER OPTION **TRIDONIC / OSRAM / KEGU**

TECH. DRAWING size in mm

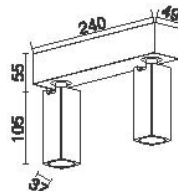

SURFACE MOUNTED LIGHT



LED  100-240 V IP20 Bridgelux AREEK

	W	LUM	CCT	BEAM	CRI
XD2232	3x8	3x550	3000K	20°	80

ROBOT FAMILY- TILTABLE & ROTATABLE

OPTIONS

Color	<input type="radio"/> RAL 9016	<input type="radio"/> RAL 9006	<input type="radio"/> RAL 9005
Beam Angle	<input type="radio"/> 20°	<input type="radio"/> 40°	<input type="radio"/> 60°
CCT	<input type="radio"/> 2700K	<input type="radio"/> 3000K	<input type="radio"/> 4000K
CRI	<input type="radio"/> 80	<input type="radio"/> 90	

SOURCE OPTION **EVERCORE**

DRIVER OPTION **TRIDONIC / OSRAM / KEGU**

TECH. DRAWING size in mm

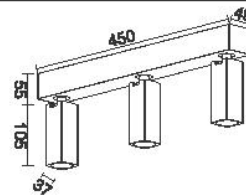

LED  100-240 V IP20 Bridgelux AREEK

	W	LUM	CCT	BEAM	CRI
XD2193	4x8	4x550	3000K	20°	80

ROBOT FAMILY- TILTABLE & ROTATABLE

OPTIONS

Color	<input type="radio"/> RAL 9016	<input type="radio"/> RAL 9006	<input type="radio"/> RAL 9005
Beam Angle	<input type="radio"/> 20°	<input type="radio"/> 40°	<input type="radio"/> 60°
CCT	<input type="radio"/> 2700K	<input type="radio"/> 3000K	<input type="radio"/> 4000K
CRI	<input type="radio"/> 80	<input type="radio"/> 90	

SOURCE OPTION **EVERCORE**

DRIVER OPTION **TRIDONIC / OSRAM / KEGU**

TECH. DRAWING size in mm

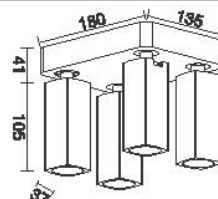

SURFACE MOUNTED LIGHT



LED  220-240 V IP20 Bridgelux OSRAM

	W	LUM	CCT	BEAM	CRI
XD2228	2x8	2x424	3000K	20°	80

XD2228- TILTABLE & ROTATABLE

OPTIONS

Color	<input type="radio"/> RAL 9016	<input type="radio"/> RAL 9006	<input type="radio"/> RAL 9005
Beam Angel	<input type="radio"/> 20°	<input type="radio"/> 40°	<input type="radio"/> 60°
CCT	<input type="radio"/> 2700K	<input type="radio"/> 3000K	<input type="radio"/> 4000K
CRI	<input type="radio"/> 80	<input type="radio"/> 90	

SOURCE OPTION /

DRIVER OPTION /

TECH. DRAWING size in mm

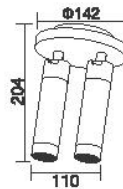

LED  220-240 V IP20 Bridgelux OSRAM

	W	LUM	CCT	BEAM	CRI
XD2229	8	424	3000K	20°	80

XD2229- TILTABLE & ROTATABLE

OPTIONS

Color	<input type="radio"/> RAL 9016	<input type="radio"/> RAL 9006	<input type="radio"/> RAL 9005
CCT	<input type="radio"/> 20°	<input type="radio"/> 40°	<input type="radio"/> 60°
CCT	<input type="radio"/> 2700K	<input type="radio"/> 3000K	<input type="radio"/> 4000K
CRI	<input type="radio"/> 80	<input type="radio"/> 90	

SOURCE OPTION /

DRIVER OPTIONS /

TECH. DRAWING size in mm

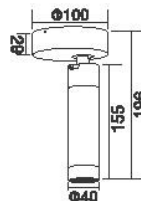

SURFACE MOUNTED LIGHT



EXTREM NARROW BEAM ANGLE TILTABLE & ROTATABLE CEILING LIGHT

OPTIONS

IP Rating	<input type="radio"/> IP20	<input type="radio"/> IP65	
Color	<input type="radio"/> RAL 9016	<input type="radio"/> RAL 9006	<input type="radio"/> RAL 9005
CCT	<input type="radio"/> 2700K	<input type="radio"/> 3000K	<input type="radio"/> 4000K
CRI	<input type="radio"/> 80	<input type="radio"/> 90	

SOURCE OPTION /

DRIVER OPTION HEP / KEGU

LED 100-240 V IP65 CREE AREEK

	W	LUM	CCT	BEAM	CRI
XD2145	8	560	3000K	4°	80

TECH. DRAWING size in mm

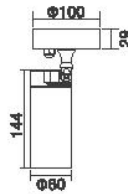

EXTREM NARROW BEAM ANGLE TILTABLE & ROTATABLE CEILING LIGHT

OPTIONS

IP Rating	<input type="radio"/> IP20	<input type="radio"/> IP65		
Color	<input type="radio"/> RAL 9016	<input type="radio"/> RAL 9006	<input type="radio"/> RAL 9005	
Beam Angle	<input type="radio"/> 15°	<input type="radio"/> 25°	<input type="radio"/> 38°	<input type="radio"/> 60°
CCT	<input type="radio"/> 2700K	<input type="radio"/> 3000K	<input type="radio"/> 4000K	
CRI	<input type="radio"/> 80	<input type="radio"/> 90		

SOURCE OPTION Bridgelux

DRIVER OPTION TRIDONIC / HEP

LED 100-240 V IP65 CITIZEN AREEK

	W	LUM	CCT	BEAM	CRI
XD2145A	12	600	3000K	25°	80

TECH. DRAWING size in mm

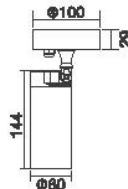

SURFACE MOUNTED LIGHT



LED  100-240 V IP20 CREE AREEK

	W	LUM	CCT	BEAM	CRI
XD2155	8	480	3000K	4°	80

EXTREM NARROW BEAM ANGLE TILTABLE RECESSED DOWNLIGHT

OPTIONS

Color RAL 9016 RAL 9006 RAL 9005

CCT 2700K 3000K 4000K

CRI 80 90

SOURCE OPTION /

DRIVER OPTION HEP / KEGU

TECH. DRAWING size in mm

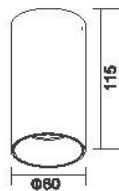

LED  100-240 V IP20 CITIZEN AREEK

	W	LUM	CCT	BEAM	CRI
XD2155A	12	600	3000K	25°	80

EXTREM NARROW BEAM ANGLE TILTABLE RECESSED DOWNLIGHT

OPTIONS

Color RAL 9016 RAL 9006 RAL 9005

Beam Angle 15° 25° 38° 60°

CCT 2700K 3000K 4000K

CRI 80 90

SOURCE OPTION Bridgelux

DRIVER OPTION TRIDONIC / HEP

TECH. DRAWING size in mm

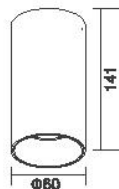

SURFACE MOUNTED LIGHT



MULTIS SQUARE FAMILY FIXED CEILING LIGHT

OPTIONS

Color	<input type="radio"/> RAL 9016	<input type="radio"/> RAL 9006	<input type="radio"/> RAL 9005
Beam Angle	<input type="radio"/> 15°	<input type="radio"/> 24°	<input type="radio"/> 36°
CCT	<input type="radio"/> 2700K	<input type="radio"/> 3000K	<input type="radio"/> 4000K
CRI	<input type="radio"/> 80	<input type="radio"/> 90	

SOURCE OPTION OSRAM

DRIVER OPTION TRIDONIC / LIFUD / AREEK

LED  220-240 V IP20 Bridgelux KEGU

	W	LUM	CCT	BEAM	CRI
XD2150	12	1080	3000K	36°	80

TECH. DRAWING size in mm

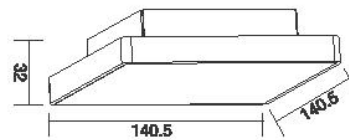

MULTIS ROUND FAMILY FIXED CEILING LIGHT

OPTIONS

Color	<input type="radio"/> RAL 9016	<input type="radio"/> RAL 9006	<input type="radio"/> RAL 9005
Beam Angle	<input type="radio"/> 15°	<input type="radio"/> 24°	<input type="radio"/> 36°
CCT	<input type="radio"/> 2700K	<input type="radio"/> 3000K	<input type="radio"/> 4000K
CRI	<input type="radio"/> 80	<input type="radio"/> 90	

SOURCE OPTION OSRAM

DRIVER OPTION TRIDONIC / LIFUD / AREEK

LED  220-240 V IP20 Bridgelux KEGU

	W	LUM	CCT	BEAM	CRI
XD2153	12	1080	3000K	36°	80

TECH. DRAWING size in mm

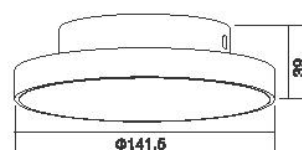

SURFACE MOUNTED LIGHT



LED  220-240 V IP20 CITIZEN KEGU

	W	LUM	CCT	BEAM	CRI
XD2151	8	800	3000K	38°	80

IBIS FAMILY - 360° GIMBAL

OPTIONS

Color	<input type="radio"/> RAL 9016	<input type="radio"/> RAL 9006	<input type="radio"/> RAL 9005	
Beam Angle	<input type="radio"/> 15°	<input type="radio"/> 25°	<input type="radio"/> 38°	<input type="radio"/> 60°
CCT	<input type="radio"/> 2700K	<input type="radio"/> 3000K	<input type="radio"/> 4000K	
CRI	<input type="radio"/> 80	<input type="radio"/> 90		

SOURCE OPTION **Bridgelux / EVERCORE**

DRIVER OPTION **AREEK / HEP**

TECH. DRAWING size in mm

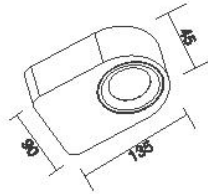

LED  220-240 V IP20 CITIZEN KEGU

	W	LUM	CCT	BEAM	CRI
XD2152	2x8	2x800	3000K	38°	80

IBIS FAMILY - 360° GIMBAL

OPTIONS

Color	<input type="radio"/> RAL 9016	<input type="radio"/> RAL 9006	<input type="radio"/> RAL 9005	
Beam Angle	<input type="radio"/> 15°	<input type="radio"/> 25°	<input type="radio"/> 38°	<input type="radio"/> 60°
CCT	<input type="radio"/> 2700K	<input type="radio"/> 3000K	<input type="radio"/> 4000K	
CRI	<input type="radio"/> 80	<input type="radio"/> 90		

SOURCE OPTION **Bridgelux / EVERCORE**

DRIVER OPTION **AREEK / HEP**

TECH. DRAWING size in mm

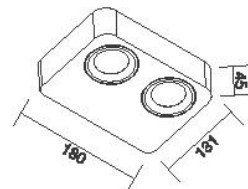

SURFACE MOUNTED LIGHT



LED  220-240 V IP20 Bridgelux KEGU

	W	LUM	CCT	BEAM	CRI
XD2157	12	1080	3000K	36°	80

MULTISQUARE FAMILY TILTABLE & ROTATABLE CEILING LIGHT

OPTIONS

Color	<input type="radio"/> RAL 9016	<input type="radio"/> RAL 9006	<input type="radio"/> RAL 9005
Beam Angle	<input type="radio"/> 15°	<input type="radio"/> 24°	<input type="radio"/> 36°
CCT	<input type="radio"/> 2700K	<input type="radio"/> 3000K	<input type="radio"/> 4000K
CRI	<input type="radio"/> 80	<input type="radio"/> 90	

SOURCE OPTION OSRAM

DRIVER OPTION TRIDONIC / LIFUD / AREEK

TECH. DRAWING size in mm

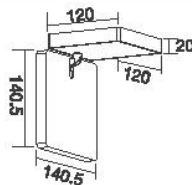

LED  220-240 V IP20 Bridgelux KEGU

	W	LUM	CCT	BEAM	CRI
XD2158	12	1080	3000K	36°	80

MULTISQUARE FAMILY TILTABLE & ROTATABLE CEILING LIGHT

OPTIONS

Color	<input type="radio"/> RAL 9016	<input type="radio"/> RAL 9006	<input type="radio"/> RAL 9005
Beam Angle	<input type="radio"/> 15°	<input type="radio"/> 24°	<input type="radio"/> 36°
CCT	<input type="radio"/> 2700K	<input type="radio"/> 3000K	<input type="radio"/> 4000K
CRI	<input type="radio"/> 80	<input type="radio"/> 90	

SOURCE OPTION OSRAM

DRIVER OPTION TRIDONIC / LIFUD / AREEK

TECH. DRAWING size in mm

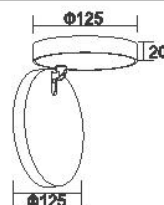

SURFACE MOUNTED LIGHT



ANTORCHA FAMILY FIXED CEILING LIGHT

TECH. DRAWING

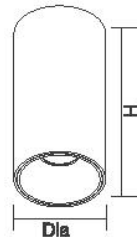

ANTORCHA FAMILY

LED  220-240 V IP20  

	W	LUM	CCT	BEAM	CRI	DIA	H
XD2197	10	700	3000K	20°	80	Φ76mm	150mm
XD2198	20	1400	3000K	20°	80	Φ96mm	150mm
XD2200	30	2100	3000K	20°	80	Φ116mm	150mm

OPTIONS

Color RAL 9016 RAL 9006 RAL 9005
 Beam Angle 20° 45°
 CCT 2700K 3000K 4000K
 CRI 80 90

SOURCE OPTION

CITIZEN

DRIVER OPTION

OSRAM

REFERENCE DRAWING

XD2197

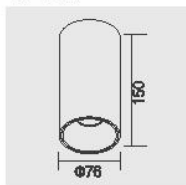

XD2198

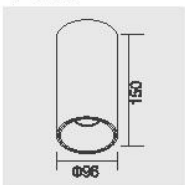

XD2200

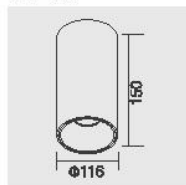

SURFACE MOUNTED LIGHT



ILUSION FAMILY FIXED CEILING LIGHT

TECH. DRAWING



ILUSION FAMILY

LED  220-240 V IP20 **Bridgelux** **TRIDONIC**

	W	LUM	CCT	BEAM	CRI	LxT	H
XD2204	10	700	3000K	20°	80	76x76mm	150mm
XD2199	20	1400	3000K	20°	80	96x96mm	150mm
XD2201	30	2100	3000K	20°	80	116x116mm	150mm

OPTIONS

Color RAL 9016 RAL 9006 RAL 9005
 Beam Angle 20° 45°
 CCT 2700K 3000K 4000K
 CRI 80 90

SOURCE OPTION

CITIZEN

DRIVER OPTION

OSRAM

REFERENCE DRAWING

XD2204

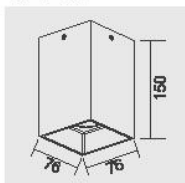

XD2199

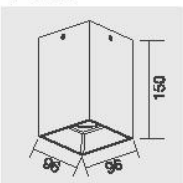

XD2201

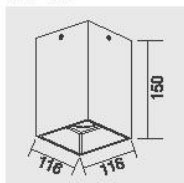

SURFACE MOUNTED LIGHT



PORTO FAMILY FIXED CEILING LIGHT

TECH. DRAWING

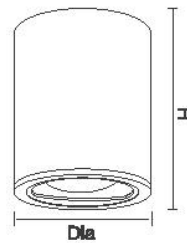

PORTO FAMILY

LED  220-240 V IP20 CITIZEN OSRAM

	W	LUM	CCT	BEAM	CRI	DIA	H
XD2205	10	600	3000K	80°	80	Ø90mm	120mm
XD2206	20	1200	3000K	80°	80	Ø113mm	146mm
XD2207	30	2100	3000K	80°	80	Ø140mm	166mm

OPTIONS

Color RAL 9016 RAL 9006 RAL 9005

CCT 2700K 3000K 4000K

CRI 80 90

SOURCE OPTION

Brigolux

DRIVER OPTION

KEGU / AREEK

REFERENCE DRAWING

XD2205

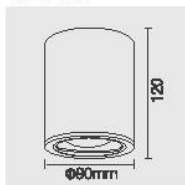

XD2206



XD2207

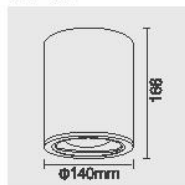

SURFACE MOUNTED LIGHT



ZOOMER FAMILY TILTABLE & ROTATABLE ZOOMER CEILING LIGHT

TECH. DRAWING

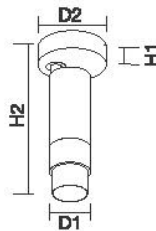

ZOOMER FAMILY

LED 100-240 V IP20 XD2211 **Bridgelux** XD2212 **CITIZEN** **AREEK**

	W	LUM	CCT	BEAM	CRI	D1	D2	H1	H2
XD2211	15	360-530	3000K	8-45°	80	Φ60mm	Φ100mm	29mm	244mm
XD2212	30	1150-2250	3000K	18-55°	80	Φ76mm	Φ100mm	29mm	285mm

OPTIONS

Color RAL 9016 RAL 9006 RAL 9005

CCT 2700K 3000K 4000K

CRI 80 90

XD2211 SOURCE OPTION

OSRAM

XD2212 SOURCE OPTION

Bridgelux

DRIVER OPTION

OSRAM / TCI / TRIDONIC

REFERENCE DRAWING

XD2211

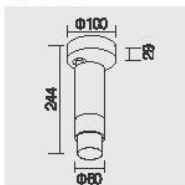

XD2212

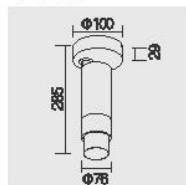

SURFACE MOUNTED LIGHT



ASTREA LENS CHANGEABLE CEILING LIGHT

TECH. DRAWING

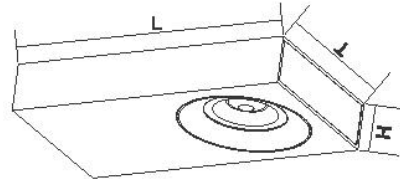

ASTREA FAMILY

LED 220-240 V IP20 CITIZEN TRIDONIC

	W	LUM	CCT	BEAM	CRI	L	T	H
XD2196	15	1200-1400	3000K	/	80	180mm	100mm	30mm

OPTIONS

- Color RAL 9016 RAL 9006 RAL 9005
 CCT 2700K 3000K 4000K
 CRI 80 90

SOURCE OPTION Bridgelux

DRIVER OPTION OSRAM

LENS OPTIONS

RONDA-WAS2-C



RONDA-WAS-C



RONDA-ZT45-C



RONDA-O-C



RONDA-WW-C



RONDA-REC-60-C



RONDA-W-C



RONDA-WWW-C



RONDA-REC-C



RONDA-S-C



SURFACE MOUNTED LIGHT



ASTREA LENS CHANGEABLE CEILING LIGHT

TECH. DRAWING



ASTREA FAMILY

LED 220-240 V IP20 CITIZEN OSRAM

	W	LUM	CCT	BEAM	CRI	L	T	H
XD2217	2x15	300-1800	3000K	/	80	280mm	100mm	30mm

OPTIONS

Color RAL 9016 RAL 9006 RAL 9005

CCT 2700K 3000K 4000K

CRI 80 90

SOURCE OPTION

Bridgelux

DRIVER OPTION

/

LENS OPTIONS

RONDA-WAS2-C



RONDA-WAS-C



RONDA-ZT45-C



RONDA-O-C



RONDA-WWC



RONDA-REC-60-C



RONDA-W-C



RONDA-WWC



RONDA-REC-C



RONDA-S-C



SURFACE MOUNTED LIGHT



ASTREA LENS CHANGEABLE CEILING LIGHT

TECH. DRAWING

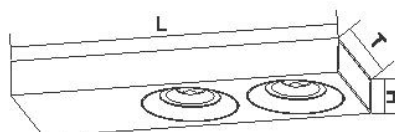

ASTREA FAMILY

LED 220-240 V IP20 CITIZEN OSRAM

	W	LUM	CCT	BEAM	CRI	L	T	H
XD2218	2x15	500-1400	3000K	/	80	280mm	100mm	30mm

OPTIONS

Color RAL 9016 RAL 9006 RAL 9005

CCT 2700K 3000K 4000K

CRI 80 90

SOURCE OPTION

Bridgelux

DRIVER OPTION

/

LENS OPTIONS

RONDA-WAS2-C



RONDA-WAS-C



RONDA-ZT45-C



RONDA-O-C



RONDA-WWC



RONDA-REC-60-C



RONDA-W-C



RONDA-WWC



RONDA-REC-C



RONDA-S-C



SURFACE MOUNTED LIGHT



LED  100-240 V IP20 NICHIA AREEK

	W	LUM	CCT	BEAM	CRI
XD2021	12	850	3000K	50°	80

XD2021- TILTABLE & ROTATABLE

OPTIONS

Color RAL 9016 RAL 9006 RAL 9005

CCT 2700K 3000K 4000K

CRI 80 90

SOURCE OPTION /

DRIVER OPTION OSRAM

TECH. DRAWING size in mm

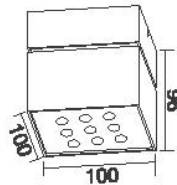

LED  100-240 V IP20 CITIZEN AREEK

	W	LUM	CCT	BEAM	CRI
XD2021B	16	1200	3000K	24°	80

XD2021B- TILTABLE & ROTATABLE

OPTIONS

Color RAL 9016 RAL 9006 RAL 9005

Beam Angle 17° 24° 60°

CCT 2700K 3000K 4000K

CRI 80 90

SOURCE OPTION Bridgelux

DRIVER OPTION OSRAM / AREEK

TECH. DRAWING size in mm



SURFACE MOUNTED LIGHT



LED  220-240 V IP20 Bridgelux KEGU

	W	LUM	CCT	BEAM	CRI
XD2022A	26	1800	3000K	18°	80

XD2022A- TILTABLE & ROTATABLE

OPTIONS

Color RAL 9016 RAL 9006 RAL 9005

CCT 2700K 3000K 4000K

CRI 80 90

SOURCE OPTION **CITIZEN**

DRIVER OPTION **OSRAM / AREEK**

TECH. DRAWING size in mm

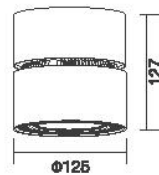

LED  220-240 V IP20 Bridgelux HEP

	W	LUM	CCT	BEAM	CRI
XD2104	12	840	3000K	35°	80

XD2104- TILTABLE & ROTATABLE

OPTIONS

Color RAL 9016 RAL 9006 RAL 9005

CCT 2700K 3000K 4000K

CRI 80 90

SOURCE OPTION **CITIZEN**

DRIVER OPTION **OSRAM / AREEK**

TECH. DRAWING size in mm

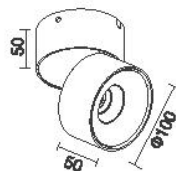

SURFACE MOUNTED LIGHT



LED  220-240 V IP20 Bridgelux KEGU

	W	LUM	CCT	BEAM	CRI
XD2036-1	8	640	3000K	30°	80

SARDINE FAMILY - TILTABLE

OPTIONS

Color RAL 9016 RAL 9006 RAL 9005

CCT 2700K 3000K 4000K

CRI 80 90

SOURCE OPTION CITIZEN / EVERCORE

DRIVER OPTION AREEK

TECH. DRAWING size in mm



LED  220-240 V IP20 Bridgelux KEGU

	W	LUM	CCT	BEAM	CRI
XD2036-2	2x8	2x640	3000K	30°	80

SARDINE FAMILY - TILTABLE

OPTIONS

Color RAL 9016 RAL 9006 RAL 9005

CCT 2700K 3000K 4000K

CRI 80 90

SOURCE OPTION CITIZEN / EVERCORE

DRIVER OPTION TRIDONIC

TECH. DRAWING size in mm

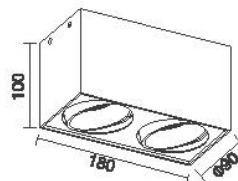

SURFACE MOUNTED LIGHT



JELLYFISH FAMILY FIXED CEILING LIGHT

TECH. DRAWING

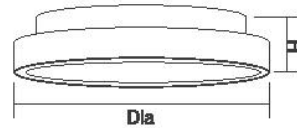

JELLYFISH FAMILY

LED  AC 220-240 V IP20 SMD 2835

	W	LUM	CCT	BEAM	CRI	DIA	H
XD2097	25	1250	3000K	115°	80	Φ368mm	82mm
XD2096	30	1500	3000K	115°	80	Φ417mm	82mm

OPTIONS

Color RAL 9016 RAL 9006 RAL 9005

CCT 2700K 3000K 4000K

CRI 80 90

SOURCE OPTION

/

DRIVER OPTION

/

REFERENCE DRAWING

XD2097



XD2096



SURFACE MOUNTED LIGHT



LED  100-240 V IP20 EVERCORE AREEK

	W	LUM	CCT	BEAM	CRI
XD2127	8	660	3000K	24°	80

CUP FAMILY - FIXED CEILING LIGHT

OPTIONS

Color RAL 9016 RAL 9006 RAL 9005
 Beam Angle 15° 24° 38° 60°
 CCT 2700K 3000K 4000K
 CRI 80 90

SOURCE OPTION **Bridgelux / CITIZEN**

DRIVER OPTION **KEQU / LIFUD**

TECH. DRAWING size in mm

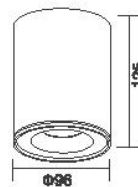

LED  100-240 V IP20 EVERCORE AREEK

	W	LUM	CCT	BEAM	CRI
XD2128	8	660	3000K	24°	80

CUP FAMILY - TILTABLE CEILING LIGHT

OPTIONS

Color RAL 9016 RAL 9006 RAL 9005
 Beam Angle 15° 24° 38° 60°
 CCT 2700K 3000K 4000K
 CRI 80 90

SOURCE OPTION **Bridgelux / CITIZEN**

DRIVER OPTION **KEQU / LIFUD**

TECH. DRAWING size in mm

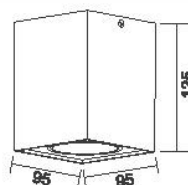

SURFACE MOUNTED LIGHT



XD2165

OPTIONS

Color	<input type="radio"/> RAL 9016	<input type="radio"/> RAL 9006	<input type="radio"/> RAL 9005
Beam Angle	<input type="radio"/> 15°	<input type="radio"/> 24°	<input type="radio"/> 36°
CCT	<input type="radio"/> 2700K	<input type="radio"/> 3000K	<input type="radio"/> 4000K
CRI	<input type="radio"/> 80	<input type="radio"/> 90	

SOURCE OPTION **Bridgelux**

DRIVER OPTION **/**

LED  100-240 V IP20 CITIZEN AREEK

	W	LUM	CCT	BEAM	CRI
XD2165	10	632	3000K	24°	80

TECH. DRAWING size in mm

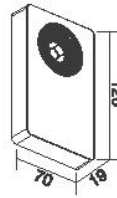

CONE FAMILY - FIXED CEILING LIGHT

OPTIONS

Color	<input type="radio"/> RAL 9016	<input type="radio"/> RAL 9006	<input type="radio"/> RAL 9005
CCT	<input type="radio"/> 2700K	<input type="radio"/> 3000K	<input type="radio"/> 4000K
CRI	<input type="radio"/> 80	<input type="radio"/> 90	

SOURCE OPTION **Bridgelux**

DRIVER OPTION **OSRAM / LIFUD / TRIDONIC / AREEK**

LED  220-240 V IP20 CITIZEN KEGU

	W	LUM	CCT	BEAM	CRI
XD2048	40	3200	3000K	25°	80

TECH. DRAWING size in mm

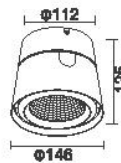

SURFACE MOUNTED LIGHT



LED  100-240 V IP20 SMD AREEK

	W	LUM	CCT	BEAM	CRI
XD2081	30	1920	3000K	116°	80

XD2081

OPTIONS

Color RAL 9018 RAL 9006 RAL 9005

CCT 2700K 3000K 4000K

CRI 80 90

SOURCE OPTION /

DRIVER OPTION /

TECH. DRAWING size in mm

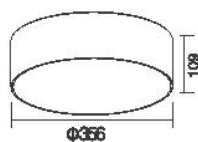

PENDANT LIGHT



LED  220-240 V IP20 SMD ARIEEL

	W	LUM	CCT	BEAM	CRI
KF1027A	37	1850	3000K	180°	80

KF1027A MOTION SENSOR UP & DOWN PENDANT LIGHT

OPTIONS

Color RAL 9016 RAL 9006 RAL 9005

CCT 2700K 3000K 4000K

CRI 80 90

SOURCE OPTION /

DRIVER OPTION OSRAM / LIFUD / TRIDONIC

TECH. DRAWING size in mm

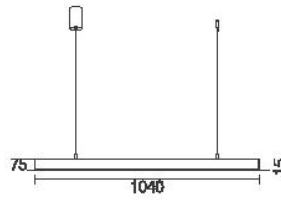

LED  220-240 V IP20 EDISON TCI

	W	LUM	CCT	BEAM	CRI
KF1064	37 (up)	3700 (up)	3000K	132° (up)	80
	13 (down)	1300 (down)		80° (down)	

KF1064 MOTION SENSOR UP & DOWN PENDANT LIGHT

OPTIONS

Color RAL 9016 RAL 9006 RAL 9005

CCT 2700K 3000K 4000K

CRI 80 90

SOURCE OPTION /

DRIVER OPTIONS /

TECH. DRAWING size in mm

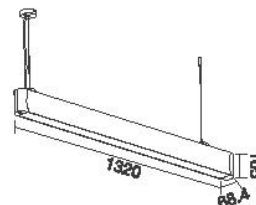

PENDANT LIGHT



KF1028 / KF1029 FIXED PENDANT LIGHT

TECH. DRAWING

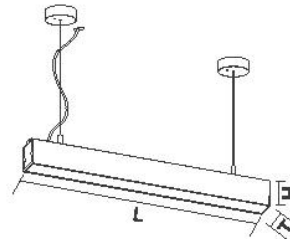

KF1028 / KF1029

LED  220-240 V IP20 EDISON TRIDONIC

	W	LUM	CCT	BEAM	CRI	L	H	T
KF1028	18	1700	3000K	100°	80	569mm	66mm	50mm
KF1029	36	3400	3000K	100°	80	1130mm	66mm	50mm

OPTIONS

Color RAL 9016 RAL 9006 RAL 9005

CCT 2700K 3000K 4000K

CRI 80 90

SOURCE OPTION

EVERLIGHT

DRIVER OPTION

OSRAM / KEGU

REFERENCE DRAWING

KF1028

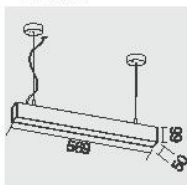

KF1029

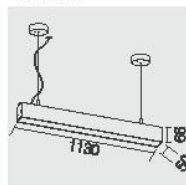

PENDANT LIGHT



JELLYFISH FAMILY FIXED PENDANT LIGHT

TECH. DRAWING

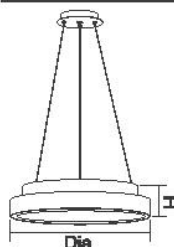

JELLYFISH FAMILY

LED  AC 220-240 V IP20 SMD 2835

	W	LUM	CCT	BEAM	CRI	DIA	H
KF1031	25	1160	3000K	115°	80	Φ368mm	82mm
KF1030	30	1410	3000K	115°	80	Φ417mm	82mm

OPTIONS

Color RAL 9016 RAL 9006 RAL 9005

CCT 2700K 3000K 4000K

CRI 80 90

SOURCE OPTION

/

DRIVER OPTION

/

REFERENCE DRAWING

KF1031



KF1030



PENDANT LIGHT



ZOOMER FAMILY ZOOMER PENDANT LIGHT

TECH. DRAWING

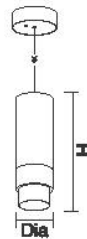

ZOOMER FAMILY

LED  100-240 V IP20 **KF1060** Bridgelux **KF1059** CITIZEN **AREEK**

	W	LUM	CCT	BEAM	CRI	DIA	H
KF1060	15	360-530	3000K	8-45°	80	Ø60mm	169mm
KF1059	30	1150-2250	3000K	18-55°	80	Ø76mm	234mm

OPTIONS

Color RAL 9016 RAL 9006 RAL 9005

CCT 2700K 3000K 4000K

CRI 80 90

KF1060 SOURCE OPTION **CITIZEN**

KF1059 SOURCE OPTION **Bridgelux**

DRIVER OPTION **OSRAM / TRIDONIC / TCI**

REFERENCE DRAWING

KF1060

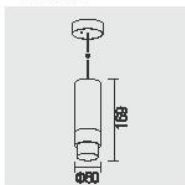

KF1059

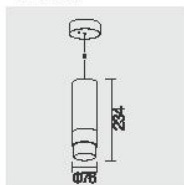

PENDANT LIGHT



LESS FAMILY FIXED PENDANT LIGHT

TECH. DRAWING

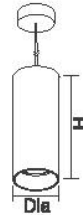

LESS FAMILY

LED 220-240 V IP20 CITIZEN OSRAM

	W	LUM	CCT	BEAM	CRI	DIA	H
SL370	20	1400	3000K	38°	80	Ø76mm	190mm
SL371	30	2100	3000K	30°	80	Ø89mm	210mm

OPTIONS

- Color RAL 9016 RAL 9006 RAL 9005
- Beam Angle 15° 24° 36°
- Beam Angle 18° 30°
- CCT 2700K 3000K 4000K
- CRI 80 90

SOURCE OPTION

EVERCORE / Bridgelux

DRIVER OPTION

TRIDONIC / LIFUD / AREEK

REFERENCE DRAWING

SL370

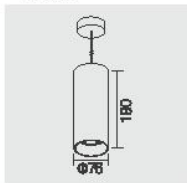

SL371

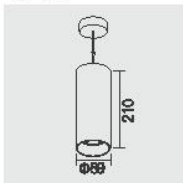

PENDANT LIGHT



VERINA FAMILY FIXED PENDANT LIGHT

TECH. DRAWING

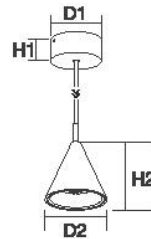

VERINA FAMILY

LED 100-240 V IP20 CITIZEN AREEK

	W	LUM	CCT	BEAM	CRI	D1	D2	H1	H2
SL372	5	360	3000K	110°	80	Ø80mm	Ø74mm	35mm	85mm
SL373	10	700	3000K	110°	80	Ø80mm	Ø95mm	35mm	98mm
SL374	20	1400	3000K	110°	80	Ø100mm	Ø138mm	43.5mm	135mm

OPTIONS

Color RAL 9016 RAL 9006 RAL 9005

CCT 2700K 3000K 4000K

CRI 80 90

SOURCE OPTION

BridgeLux

DRIVER OPTION

LIFUD

REFERENCE DRAWING

SL372

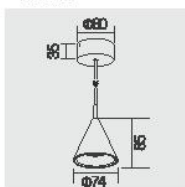

SL373

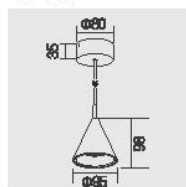

SL374

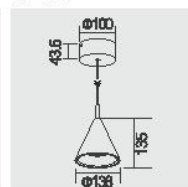

PENDANT LIGHT



LED 100-240 V IP20 CREE AREEK

	W	LUM	CCT	BEAM	CRI
SL385	8	540	3000K	4°	80

EXTREM NARROW BEAM ANGLE FIXED PENDANT LIGHT

OPTIONS

Color RAL 9016 RAL 9006 RAL 9005

CCT 2700K 3000K 4000K

CRI 80 90

SOURCE OPTION /

DRIVER OPTION HEP / KEGU

TECH. DRAWING size in mm

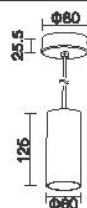

LED 100-240 V IP20 CITIZEN AREEK

	W	LUM	CCT	BEAM	CRI
SL385A	12	640	3000K	25°	80

EXTREM NARROW BEAM ANGLE FIXED PENDANT LIGHT

OPTIONS

Color RAL 9016 RAL 9006 RAL 9005

Beam Angle 15° 25° 38° 60°

CCT 2700K 3000K 4000K

CRI 80 90

SOURCE OPTION Bridgelux

DRIVER OPTION TRIDONIC / HEP

TECH. DRAWING size in mm

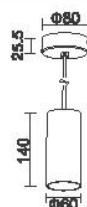

PENDANT LIGHT



LED  220-240 V IP20 Bridgelux KEGU

	W	LUM	CCT	BEAM	CRI
SL386	12	1080	3000K	36°	80

MULTISQUARE FAMILY FIXED PENDANT LIGHT

OPTIONS

Color	<input type="radio"/> RAL 9016	<input type="radio"/> RAL 9006	<input type="radio"/> RAL 9005
Beam Angle	<input type="radio"/> 15°	<input type="radio"/> 24°	<input type="radio"/> 36°
CCT	<input type="radio"/> 2700K	<input type="radio"/> 3000K	<input type="radio"/> 4000K
CRI	<input type="radio"/> 80	<input type="radio"/> 90	

SOURCE OPTION

OSRAM

DRIVER OPTION

AREEK

TECH. DRAWING size in mm

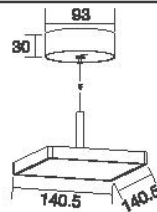

LED  220-240 V IP20 Bridgelux KEGU

	W	LUM	CCT	BEAM	CRI
SL388	12	1080	3000K	36°	80

MULTISQUARE FAMILY FIXED PENDANT LIGHT

OPTIONS

Color	<input type="radio"/> RAL 9016	<input type="radio"/> RAL 9006	<input type="radio"/> RAL 9005
Beam Angle	<input type="radio"/> 15°	<input type="radio"/> 24°	<input type="radio"/> 36°
CCT	<input type="radio"/> 2700K	<input type="radio"/> 3000K	<input type="radio"/> 4000K
CRI	<input type="radio"/> 80	<input type="radio"/> 90	

SOURCE OPTION

OSRAM

DRIVER OPTION

AREEK

TECH. DRAWING size in mm

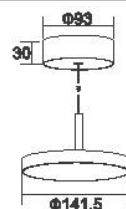

WALL LIGHT



LED  220-240 V IP20 Bridgelux KEGU

	W	LUM	CCT	BEAM	CRI
WL610	12	1080	3000K	36°	80

MULTIS SQUARE FAMILY ROTATABLE WALL LIGHT

OPTIONS

Color	<input type="radio"/> RAL 9016	<input type="radio"/> RAL 9006	<input type="radio"/> RAL 9005
Beam Angle	<input type="radio"/> 15°	<input type="radio"/> 24°	<input type="radio"/> 36°
CCT	<input type="radio"/> 2700K	<input type="radio"/> 3000K	<input type="radio"/> 4000K
CRI	<input type="radio"/> 80	<input type="radio"/> 90	

SOURCE OPTION OSRAM

DRIVER OPTION AREEK

TECH. DRAWING size in mm

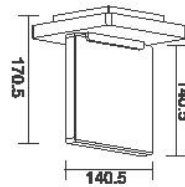

LED  220-240 V IP20 Bridgelux KEGU

	W	LUM	CCT	BEAM	CRI
WL612	12	1080	3000K	36°	80

MULTIS ROUND FAMILY ROTATABLE WALL LIGHT

OPTIONS

Color	<input type="radio"/> RAL 9016	<input type="radio"/> RAL 9006	<input type="radio"/> RAL 9005
Beam Angle	<input type="radio"/> 15°	<input type="radio"/> 24°	<input type="radio"/> 36°
CCT	<input type="radio"/> 2700K	<input type="radio"/> 3000K	<input type="radio"/> 4000K
CRI	<input type="radio"/> 80	<input type="radio"/> 90	

SOURCE OPTION OSRAM

DRIVER OPTION AREEK

TECH. DRAWING size in mm



WALL LIGHT



IBIS FAMILY - 360° GIMBAL

OPTIONS

Color	<input type="radio"/> RAL 9016	<input type="radio"/> RAL 9006	<input type="radio"/> RAL 9005	
Beam Angle	<input type="radio"/> 15°	<input type="radio"/> 25°	<input type="radio"/> 38°	<input type="radio"/> 60°
CCT	<input type="radio"/> 2700K	<input type="radio"/> 3000K	<input type="radio"/> 4000K	
CRI	<input type="radio"/> 80	<input type="radio"/> 90		

SOURCE OPTION **Bridgelux / EVERCORE**

DRIVER OPTION **AREEK**

LED  220-240 V IP20 CITIZEN KEGU

	W	LUM	CCT	BEAM	CRI
WL628	8	800	3000K	38°	80

TECH. DRAWING size in mm

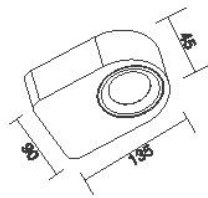

IBIS FAMILY - 360° GIMBAL

OPTIONS

Color	<input type="radio"/> RAL 9016	<input type="radio"/> RAL 9006	<input type="radio"/> RAL 9005	
Beam Angle	<input type="radio"/> 15°	<input type="radio"/> 25°	<input type="radio"/> 38°	<input type="radio"/> 60°
CCT	<input type="radio"/> 2700K	<input type="radio"/> 3000K	<input type="radio"/> 4000K	
CRI	<input type="radio"/> 80	<input type="radio"/> 90		

SOURCE OPTION **Bridgelux / EVERCORE**

DRIVER OPTION **AREEK**

LED  220-240 V IP20 CITIZEN KEGU

	W	LUM	CCT	BEAM	CRI
WL629	2x8	2x800	3000K	38°	80

TECH. DRAWING size in mm

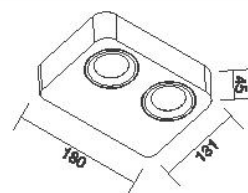

WALL LIGHT



WL396 / WL396A FIXED WALL LIGHT

TECH. DRAWING

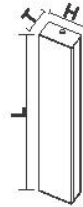

WL396 / WL396A

LED  100-240 V  SMD 

	W	LUM	CCT	BEAM	CRI	L	T	H
WL396	11	660	3000K	/	80	300mm	26.5mm	50mm
WL396A	21	1300	3000K	/	80	600mm	26.5mm	50mm

OPTIONS

Color RAL 9016 RAL 9006 RAL 9005

CCT 2700K 3000K 4000K

CRI 80 90

SOURCE OPTION

/

DRIVER OPTION

TRIDONIC

REFERENCE DRAWING

WL396

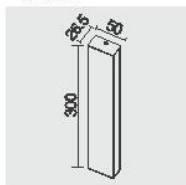

WL396A

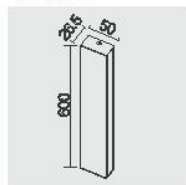

WALL LIGHT



WL398A

OPTIONS

Color RAL 9016 RAL 9006 RAL 9005

CCT 2700K 3000K 4000K

CRI 80 90

SOURCE OPTION /

DRIVER OPTION /

LED  100-240 V  IP20  SMD  AREEK

	W	LUM	CCT	BEAM	CRI
WL398A	8	620	3000K	/	80

TECH. DRAWING size in mm

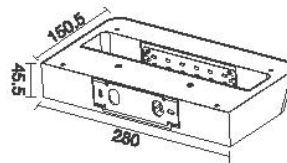

WL536

ADJUSTABLE AND UP & DOWN WALL LIGHT

OPTIONS

Color RAL 9016 RAL 9006 RAL 9005

CCT 2700K 3000K 4000K

CRI 80 90

SOURCE OPTION **Bridgelux**

DRIVER OPTION **HEP**

LED  100-240 V  IP20  CREE  AREEK

	W	LUM	CCT	BEAM	CRI
WL536	8	180	3000K	/	80

TECH. DRAWING size in mm

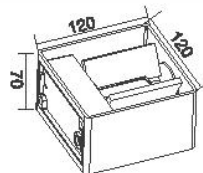

WALL LIGHT



WL537 UP & DOWN WALL LIGHT

OPTIONS

Color RAL 9016 RAL 9006 RAL 9005

CCT 2700K 3000K 4000K

CRI 80 90

SOURCE OPTION **Bridgelux**

DRIVER OPTION **HEP**

LED  100-230 V IP54 CREE AREEK

	W	LUM	CCT	BEAM	CRI
WL537	8	160	3000K	/	80

TECH. DRAWING size in mm

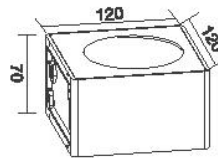

WL538 UP & DOWN WALL LIGHT

OPTIONS

Color RAL 9016 RAL 9006 RAL 9005

CCT 2700K 3000K 4000K

CRI 80 90

SOURCE OPTION **Bridgelux**

DRIVER OPTION **HEP**

LED  100-240 V IP54 CREE AREEK

	W	LUM	CCT	BEAM	CRI
WL538	2x3	2x90	3000K	/	80

TECH. DRAWING size in mm

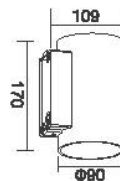

WALL LIGHT



WL541 UP & DOWN WALL LIGHT

OPTIONS

Color RAL 9016 RAL 9006 RAL 9005

CCT 2700K 3000K 4000K

CRI 80 90

SOURCE OPTION /

DRIVER OPTION HEP

LED  100-240 V IP20 Bridgelux AREEK

	W	LUM	CCT	BEAM	CRI
WL541	8	330	3000K	/	80

TECH. DRAWING size in mm

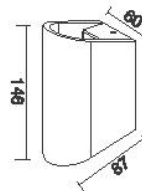

WL542 UP & DOWN WALL LIGHT

OPTIONS

Color RAL 9016 RAL 9006 RAL 9005

CCT 2700K 3000K 4000K

CRI 80 90

SOURCE OPTION /

DRIVER OPTION HEP

LED  100-240 V IP20 Bridgelux AREEK

	W	LUM	CCT	BEAM	CRI
WL542	8	330	3000K	/	80

TECH. DRAWING size in mm

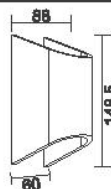

WALL LIGHT



LED  100-240 V  IP20  Bridgelux  AAREK

	W	LUM	CCT	BEAM	CRI
WL543	8	330	3000K	/	80

WL543 UP & DOWN WALL LIGHT

OPTIONS

Color RAL 9016 RAL 9006 RAL 9005

CCT 2700K 3000K 4000K

CRI 80 90

SOURCE OPTION /

DRIVER OPTION HEP

TECH. DRAWING size in mm



LED  100-240 V  IP20  Bridgelux  AAREK

	W	LUM	CCT	BEAM	CRI
WL546	8	560	3000K	/	80

WL546 UP & DOWN WALL LIGHT

OPTIONS

Color RAL 9016 RAL 9006 RAL 9005

CCT 2700K 3000K 4000K

CRI 80 90

SOURCE OPTION /

DRIVER OPTION HEP

TECH. DRAWING size in mm

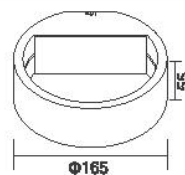

WALL LIGHT



WL572

OPTIONS

Color RAL 9016 RAL 9006 RAL 9005

CCT 2700K 3000K 4000K

CRI 80 90

SOURCE OPTION /

DRIVER OPTION OSRAM

LED  100-240 V  IP20  SMD  AFIEEK

	W	LUM	CCT	BEAM	CRI
WL572	20	980	3000K	180°	80

TECH. DRAWING size in mm

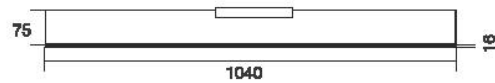

WL630

OPTIONS

Color RAL 9016 RAL 9006 RAL 9005

CCT 15° 24° 36°

CCT 2700K 3000K 4000K

CRI 80 90

SOURCE OPTION /

DRIVER OPTION /

LED  AC 220-240 V  IP20  EDISON

	W	LUM	CCT	BEAM	CRI
WL630	10	800	3000K	24°	80

TECH. DRAWING size in mm

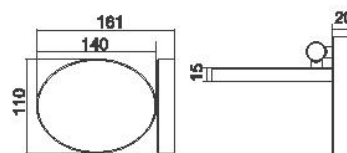

WALL LIGHT



LED  100-240 V IP20 SMD AREEK

	W	LUM	CCT	BEAM	CRI
WL611	10	600	3000K	/	80

WL611

OPTIONS

Color RAL 9016 RAL 9006 RAL 9005
 CCT 2700K 3000K 4000K
 CRI 80 90

SOURCE OPTION /

DRIVER OPTION /

TECH. DRAWING size in mm

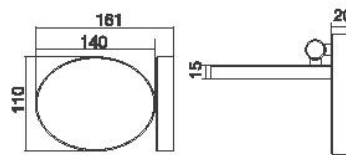

LED  100-240 V IP20 OSRAM AREEK

	W	LUM	CCT	BEAM	CRI
WL613	10	900	3000K	24°	80

WL613

OPTIONS

Color RAL 9016 RAL 9006 RAL 9005
 CCT 15° 24° 36°
 CCT 2700K 3000K 4000K
 CRI 80 90

SOURCE OPTION **Bridgelux**

DRIVER OPTION /

TECH. DRAWING size in mm

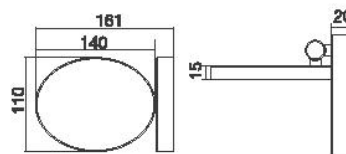

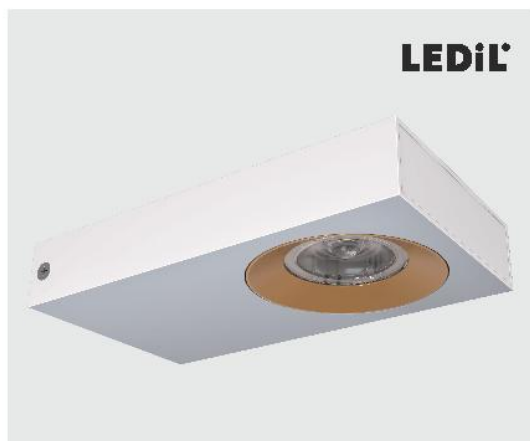

ASTREA
LENS CHANGEABLE CEILING LIGHT

TECH. DRAWING

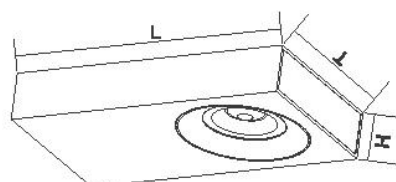

ASTREA FAMILY

LED 220-240 V IP20 CITIZEN TRIDONIC

	W	LUM	CCT	BEAM	CRI	L	T	H
WL631	15	1200-1400	3000K	30°	80	180mm	100mm	30mm

OPTIONS

Color RAL 9016 RAL 9006 RAL 9005

CCT 2700K 3000K 4000K

CRI 80 90

SOURCE OPTION OSRAM / Bridgelux

DRIVER OPTION /

LENS OPTIONS

RONDA-WAS2-C



RONDA-REC-60-C
RONDA-REC-60-C



RONDA-WAS-C



RONDA-W-C
RONDA-W-C



RONDA-ZT45-C



RONDA-WWW-C RONDA-REC-C
RONDA-WWW-C



RONDA-O-C



RONDA-WAS2-C
RONDA-REC-C



RONDA-WW-C



RONDA-S-C



OUTDOOR LIGHT



LED  220-240 V IP54 SMD LIFUD

	W	LUM	CCT	BEAM	CRI
WL622	3	48	3000K	/	80

PLUTO FAMILY- WALL LIGHT

OPTIONS

Color RAL 9016 RAL 9006 RAL 9005

CCT 2700K 3000K 4000K

CRI 80 90

SOURCE OPTION /

DRIVER OPTION /

TECH. DRAWING size in mm

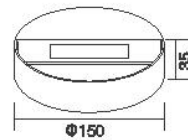

LED  220-240 V IP54 SMD LIFUD

	W	LUM	CCT	BEAM	CRI
WL623	3	42	3000K	/	80

PLUTO FAMILY- WALL LIGHT

OPTIONS

Color RAL 9016 RAL 9006 RAL 9005

CCT 2700K 3000K 4000K

CRI 80 90

SOURCE OPTION /

DRIVER OPTION /

TECH. DRAWING size in mm

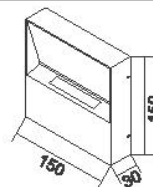

OUTDOOR LIGHT



PLUTO FAMILY- WALL LIGHT

OPTIONS

Color RAL 9016 RAL 9006 RAL 9005

CCT 2700K 3000K 4000K

CRI 80 90

SOURCE OPTION /

DRIVER OPTION /

LED  220-240 V IP54 SMD LIFUD

	W	LUM	CCT	BEAM	CRI
WL624	10	640	3000K	/	80

TECH. DRAWING size in mm

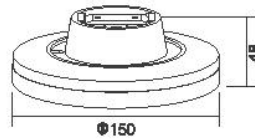

PLUTO FAMILY- WALL LIGHT

OPTIONS

Color RAL 9016 RAL 9006 RAL 9005

CCT 2700K 3000K 4000K

CRI 80 90

SOURCE OPTION /

DRIVER OPTION /

LED  220-240 V IP54 SMD LIFUD

	W	LUM	CCT	BEAM	CRI
WL625	12	696	3000K	/	80

TECH. DRAWING size in mm

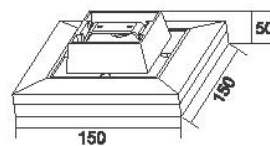

OUTDOOR LIGHT



ECLIPSE FAMILY MOULD WALL LIGHT

TECH. DRAWING

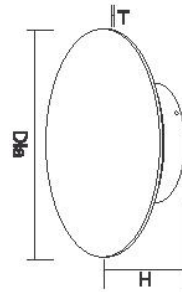

ECLIPSE FAMILY

LED  220-240 V  IP65 EDISON KEQU

	W	LUM	CCT	BEAM	CRI	DIA	T	H
WL601	10	798	3000K	/	80	Ø200mm	3mm	53mm
WL602	15	1100	3000K	/	80	Ø300mm	3mm	68mm
WL603	20	1200	3000K	/	80	Ø400mm	3mm	88mm

OPTIONS

- IP Rating IP20 IP65
 Color RAL 9016 RAL 9006 RAL 9005
 CCT 2700K 3000K 4000K
 CRI 80 90

SOURCE OPTION

TELEYA

DRIVER OPTION

AREEK

REFERENCE DRAWING

WL601

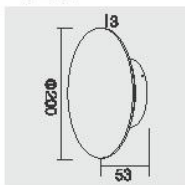

WL602

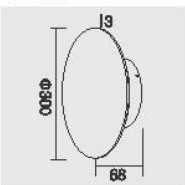

WL603

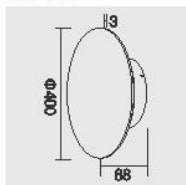

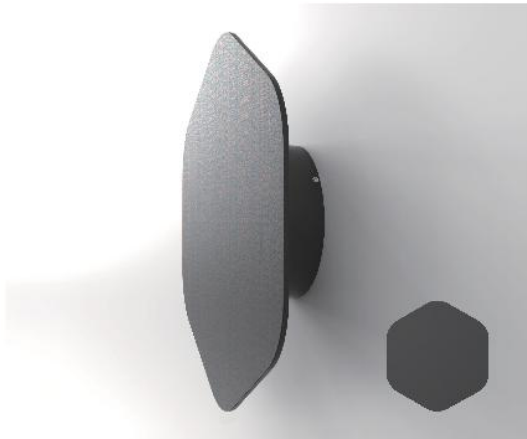

ECLIPSE FAMILY
HEXAGONAL MOULD WALL LIGHT

TECH. DRAWING

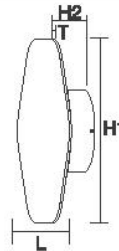

ECLIPSE FAMILY

LED 220-240 V IP65 EDISON KEQU

	W	LUM	CCT	BEAM	CRI	L	H1	T	H2
WL601A	10	798	3000K	/	80	250mm	250mm	3mm	53mm
WL602A	15	1100	3000K	/	80	300mm	300mm	3mm	68mm
WL603A	20	1200	3000K	/	80	350mm	350mm	3mm	88mm

OPTIONS

- IP Rating IP20 IP65
- Color RAL 9016 RAL 9006 RAL 9005
- CCT 2700K 3000K 4000K
- CRI 80 90

SOURCE OPTION

TELEYA

DRIVER OPTION

AREEK

REFERENCE DRAWING

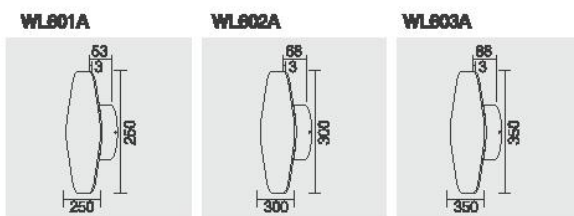

OUTDOOR LIGHT



ECLIPSE FAMILY SQUARE MOULD WALL LIGHT

TECH. DRAWING

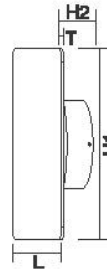

ECLIPSE FAMILY

LED  220-240 V  IP65 EDISON  KEGU

	W	LUM	CCT	BEAM	CRI	L	H1	T	H2
WL601B	10	798	3000K	/	80	220mm	220mm	3mm	53mm
WL602B	15	1100	3000K	/	80	280mm	280mm	3mm	68mm
WL603B	20	1200	3000K	/	80	380mm	380mm	3mm	83mm

OPTIONS

- IP Rating IP20 IP65
 Color RAL 9016 RAL 9006 RAL 9005
 CCT 2700K 3000K 4000K
 CRI 80 90

SOURCE OPTION

TELEYA

DRIVER OPTION

AREEK

REFERENCE DRAWING

WL601

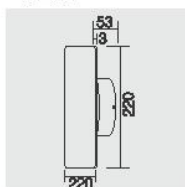

WL602

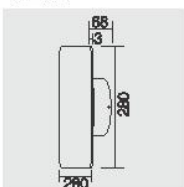

WL603

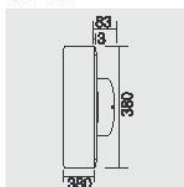

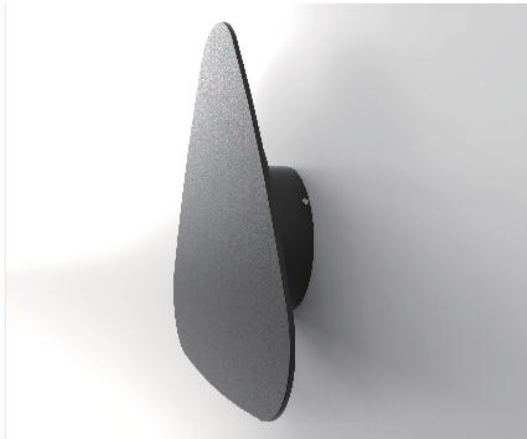

ECLIPSE FAMILY
TRIANGULAR MOULD WALL LIGHT

TECH. DRAWING

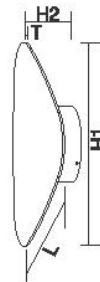

ECLIPSE FAMILY

LED  220-240 V  EDISON 

	W	LUM	CCT	BEAM	CRI	L	H1	T	H2
WL601C	10	798	3000K	/	80	300mm	300mm	3mm	53mm
WL602C	15	1100	3000K	/	80	350mm	350mm	3mm	68mm
WL603C	20	1200	3000K	/	80	400mm	400mm	3mm	88mm

OPTIONS

- IP Rating IP20 IP65
 Color RAL 9016 RAL 9006 RAL 9005
 CCT 2700K 3000K 4000K
 CRI 80 90

SOURCE OPTION	TELEYA
DRIVER OPTION	AREEK

PICTURES

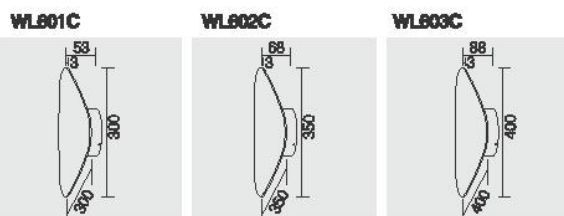

OUTDOOR LIGHT



EXTREM NARROW BEAM ANGLE TILTABLE GARDEN LIGHT

OPTIONS

Color RAL 9016 RAL 9006 RAL 9005

CCT 2700K 3000K 4000K

CRI 80 90

SOURCE OPTION /

DRIVER OPTION HEP / KEGU

LED 100-240 V IP65 CREE AREEK

	W	LUM	CCT	BEAM	CRI
FL937	8	480	3000K	4°	80

TECH. DRAWING size in mm



EXTREM NARROW BEAM ANGLE TILTABLE GARDEN LIGHT

OPTIONS

Color RAL 9016 RAL 9006 RAL 9005

Beam Angle 15° 25° 38° 60°

CCT 2700K 3000K 4000K

CRI 80 90

SOURCE OPTION Bridgelux

DRIVER OPTION TRIDONIC / HEP

LED 100-240 V IP65 CITIZEN AREEK

	W	LUM	CCT	BEAM	CRI
FL937A	12	607	3000K	25°	80

TECH. DRAWING size in mm



OUTDOOR LIGHT



EXTREM NARROW BEAM ANGLE GROUND LIGHT

OPTIONS

Color RAL 9016 RAL 9006 RAL 9005

CCT 2700K 3000K 4000K

CRI 80 90

SOURCE OPTION /

DRIVER OPTION HEP / KEGU

LED  100-240 V IP65 CREE AREEK

	W	LUM	CCT	BEAM	CRI
KT568	8	480	3000K	4°	80

TECH. DRAWING size in mm

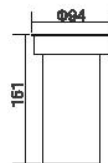

EXTREM NARROW BEAM ANGLE GROUND LIGHT

OPTIONS

Color RAL 9016 RAL 9006 RAL 9005

Beam Angle 15° 25° 38° 60°

CCT 2700K 3000K 4000K

CRI 80 90

SOURCE OPTION Bridgelux

DRIVER OPTION TRIDONIC / HEP

LED  100-240 V IP65 CITIZEN AREEK

	W	LUM	CCT	BEAM	CRI
KT568A	12	607	3000K	25°	80

TECH. DRAWING size in mm

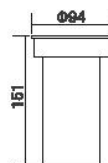

OUTDOOR LIGHT



LED  AC 220-240 V IP65 SMD

	W	LUM	CCT	BEAM	CRI
WL569	12	569	3000K	/	80

LACUNA FAMILY- IP65 WALL LIGHT

OPTIONS

Color RAL 9016 RAL 9006 RAL 9005

CCT 2700K 3000K 4000K

CRI 80 90

SOURCE OPTION /

DRIVER OPTION /

TECH. DRAWING size in mm

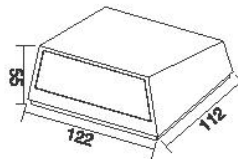

LED  AC 220-240 V IP65 SMD

	W	LUM	CCT	BEAM	CRI
WL576	16	860	3000K	/	80

LACUNA FAMILY- IP65 WALL LIGHT

OPTIONS

Color RAL 9016 RAL 9006 RAL 9005

CCT 2700K 3000K 4000K

CRI 80 90

SOURCE OPTION /

DRIVER OPTION /

TECH. DRAWING size in mm

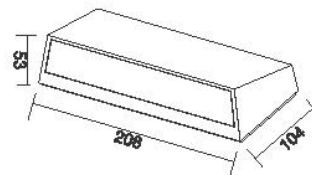

OUTDOOR LIGHT



LED  AC 220-240 V IP65 SMD

	W	LUM	CCT	BEAM	CRI
WL577	20	1000	3000K	/	80

LACUNA FAMILY- IP65 WALL LIGHT

OPTIONS

Color RAL 9016 RAL 9006 RAL 9005

CCT 2700K 3000K 4000K

CRI 80 90

SOURCE OPTION /

DRIVER OPTION /

TECH. DRAWING size in mm



LED  AC 220-240 V IP65 SMD

	W	LUM	CCT	BEAM	CRI
WL558	8	223	3000K	/	80

LACUNA FAMILY- IP65 WALL LIGHT

OPTIONS

Color RAL 9016 RAL 9006 RAL 9005

CCT 2700K 3000K 4000K

CRI 80 90

SOURCE OPTION /

DRIVER OPTION /

TECH. DRAWING size in mm

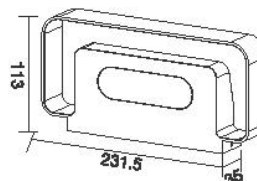

OUTDOOR LIGHT



CERTUS FAMILY FIXED WALL LIGHT

TECH. DRAWING

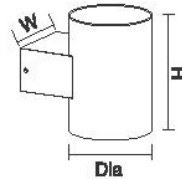

CERTUS FAMILY

LED  AC 220-240 V IP65 ZOM

	W	LUM	CCT	BEAM	CRI	DIA	W	H
WL581	2x6	2x420	3000K	30°	80	Ø65mm	56mm	90mm
WL582	2x8	2x560	3000K	30°	80	Ø91mm	91mm	125mm
WL583	2x15	2x1050	3000K	40°	80	Ø120mm	150mm	152mm

OPTIONS

Color RAL 9016 RAL 9006 RAL 9005

CCT 2700K 3000K 4000K

CRI 80 90

SOURCE OPTION

EDISON

DRIVER OPTION

/

REFERENCE DRAWING

WL581

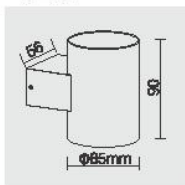

WL582

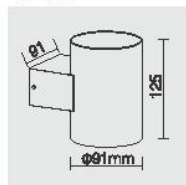

WL583

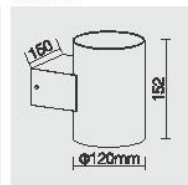



**CERTUS FAMILY
FIXED WALL LIGHT**

TECH. DRAWING

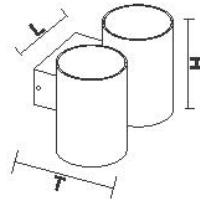

CERTUS FAMILY

LED  AC 220-240 V IP65 ZOM

	W	LUM	CCT	BEAM	CRI	L	T	H
WL581A	4x6	4x420	3000K	30°	80	148mm	95mm	90mm
WL582A	4x8	4x560	3000K	30°	80	203mm	126mm	92mm
WL583A	4x15	4x1060	3000K	40°	80	270mm	150mm	150mm

OPTIONS

Color RAL 9016 RAL 9006 RAL 9005

CCT 2700K 3000K 4000K

CRI 80 90

SOURCE OPTION

EDISON

DRIVER OPTION

/

REFERENCE DRAWING

WL581A

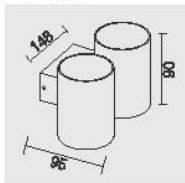

WL582A

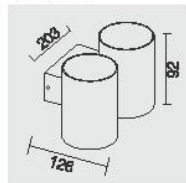

WL583A

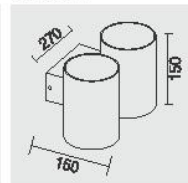

OUTDOOR LIGHT



CERTUS FAMILY FIXED WALL LIGHT

TECH. DRAWING

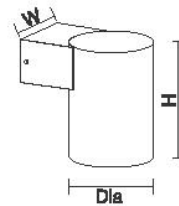

CERTUS FAMILY

LED  AC 220-240 V  ZOM

	W	LUM	CCT	BEAM	CRI	DIA	W	H
WL581B	8	540	3000K	30°	80	Ø65mm	56mm	90mm
WL582B	10	770	3000K	30°	80	Ø91mm	91mm	125mm
WL583B	20	1800	3000K	40°	80	Ø120mm	150mm	151mm

OPTIONS

Color RAL 9016 RAL 9006 RAL 9005

CCT 2700K 3000K 4000K

CRI 80 90

SOURCE OPTION

EDISON

DRIVER OPTION

/

REFERENCE DRAWING

WL581B

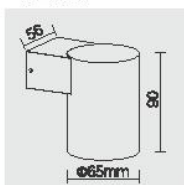

WL582B

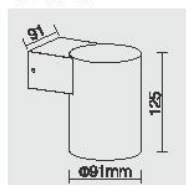

WL583B

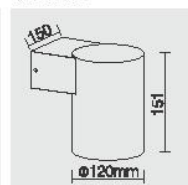

OUTDOOR LIGHT

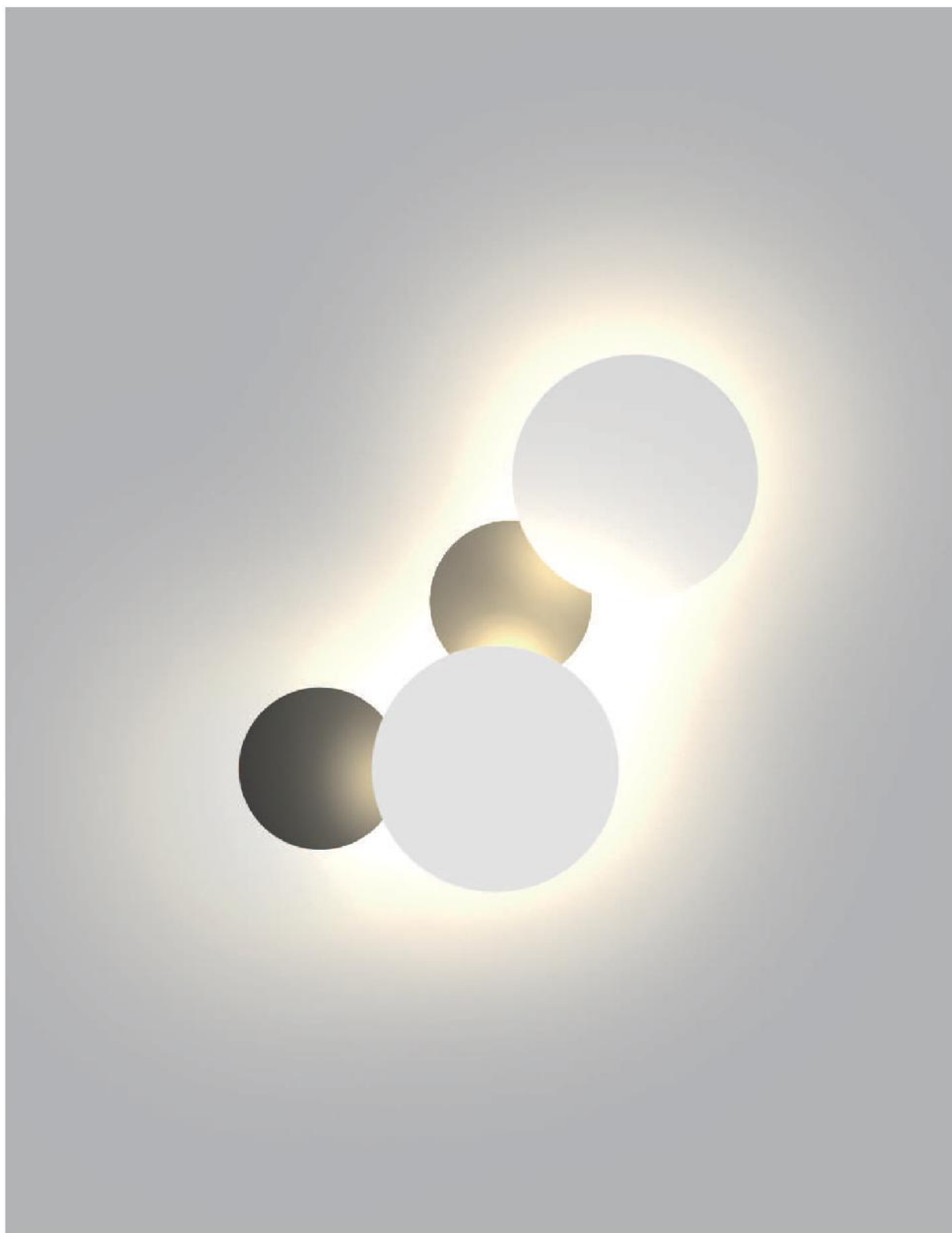

TRADITIONAL LIGHT

DOWNLIGHT

KT111E-1



LAMP SOURCE
AR111 50W

KT111E-2



LAMP SOURCE
AR111 2X50W

KT111E-3



LAMP SOURCE
AR111 3X50W

KT111E-4



LAMP SOURCE
AR111 3X50W

KT111E-4F



LAMP SOURCE
AR111 4X50W

KT111H-1



LAMP SOURCE
AR111 50W

KT111H-R



LAMP SOURCE
AR111 50W

KT111H-2



LAMP SOURCE
AR111 2X50W

KT111H-2A



LAMP SOURCE
AR111 2X50W

KT111H-3



LAMP SOURCE
AR111 3X50W

KT111H-3A



LAMP SOURCE
AR111 3X50W

KT111H-4F



LAMP SOURCE
AR111 4X50W

KT12B-1



LAMP SOURCE
G12 70W

KT12B-2



LAMP SOURCE
G12 2X70W

KT12B-3



LAMP SOURCE
G12 3X70W

KT12B-4F



LAMP SOURCE
G12 4X70W

KT16E-1



LAMP SOURCE
MR16 50W

KT16E-2



LAMP SOURCE
MR16 2X50W

KT16E-3



















LAMP SOURCE
MR16 3X50W

KT16E-4F



LAMP SOURCE
MR16 4X50W

DOWNLIGHT

<p>KT6001</p> 	<p>KT6001S</p> 	<p>KT6002</p> 	<p>KT6002S</p> 	<p>KT6014</p> 
<p>LAMP SOURCE MR16 / GU10 50W</p>	<p>LAMP SOURCE MR16 / GU10 50W</p>	<p>LAMP SOURCE MR16 / GU10 50W</p>	<p>LAMP SOURCE MR16 / GU10 50W</p>	<p>LAMP SOURCE MR11 35W</p>
<p>KT6015</p> 	<p>KT6023T</p> 	<p>KT6392</p> 	<p>KT6393</p> 	<p>KT6394</p> 
<p>LAMP SOURCE MR16 / GU10 50W</p>	<p>LAMP SOURCE MR16 / GU10 50W</p>	<p>LAMP SOURCE MR16 / GU10 50W</p>	<p>LAMP SOURCE MR16 / GU10 50W</p>	<p>LAMP SOURCE MR16 / GU10 50W</p>
<p>KT6395</p> 	<p>DL122</p> 	<p>HC122</p> 	<p>DL8001</p> 	<p>DL8061</p> 
<p>LAMP SOURCE MR16 / GU10 50W</p>	<p>LAMP SOURCE PAR38 90W</p>	<p>LAMP SOURCE PAR38 90W</p>	<p>LAMP SOURCE GU10 50W</p>	<p>LAMP SOURCE GU10 50W</p>
<p>DL8126</p> 	<p>DL8129</p> 	<p>HC8129</p> 	<p>DL8130</p> 	<p>HC8130</p> 
<p>LAMP SOURCE GU10 50W</p>	<p>LAMP SOURCE GU10 50W</p>	<p>LAMP SOURCE GU10 50W</p>	<p>LAMP SOURCE GU10 50W</p>	<p>LAMP SOURCE GU10 50W</p>

TRADITIONAL LIGHT

DOWNLIGHT

DL8140



LAMP SOURCE
PAR30 75W

DL8141



LAMP SOURCE
GU10 2X50W

DL8641



LAMP SOURCE
PAR38 90W

HC8641



LAMP SOURCE
PAR38 90W

DL8643



LAMP SOURCE
PAR30 75W

HC8643



LAMP SOURCE
PAR30 75W

XD2024



LAMP SOURCE
GU10 50W

XD2025



LAMP SOURCE
GU10 50W

XD2035



LAMP SOURCE
GU10 50W

XD2085



LAMP SOURCE
GU10 50W

XD2086



LAMP SOURCE
GU10 50W

XD2105



LAMP SOURCE
GU10 50W

SPOT LIGHT

HKT8001



LAMP SOURCE
GU10 50W

HKT8001



LAMP SOURCE
GU10 50W

KTK1-8001



LAMP SOURCE
GU10 50W

KTW8001



LAMP SOURCE
MR16 50W

KTW8001



LAMP SOURCE
MR16 50W

HKT8841



LAMP SOURCE
PAR38 90W

HKT8843



LAMP SOURCE
PAR30 75W

HKT122



LAMP SOURCE
PAR38 90W

HKT123



LAMP SOURCE
PAR30 75W

MHT122



LAMP SOURCE
PAR38 90W

MHT123



LAMP SOURCE
PAR30 75W