



KETAI

NEW ARRIVAL
Design & Manufacture
2019

KETAI INDUSTRIES LIGHTING CO., LTD

Ketai Building, 4 Mashe New Street
Lishui, Nanhai, Post code 528244, Foshan
Guangdong, China

Phone: +86 757 8560 7707

Fax: +86 757 8560 3675

e-mail: sales@ketailighting.com



www.ketailighting.com



Catalog download

KETAI

LED LIGHTING

2019-2020



JOIN US

Let Inspiration Talk



WE LOVE TO WORK & WE LOVE WHERE WE WORK

Ketai Industries Lighting Co., Ltd. was founded in 1999 in Foshan, Guangdong of China, focusing on researching, development and production of lighting including led downlights, led track lights, led wall lights, led ceiling lights, led pendant lights and led outdoor lights.

Our factory covers an area of 40000 square meters, including the die-casting workshop, stamping workshop, powder coating workshop, and assembly workshop.

We have 500 employees, our greatest advantage is to design, develop and produce the special, creative, high-tech LED lights. No matter what kinds of LED lights you want, just tell us your demand, the best solution would be provided by our professional engineers.

Our well experienced 30 engineers in the R&D dept. customize available solutions for various lighting projects and, free design drawing can be provided according to customer's demand.

We are ISO 9001 certified manufacturer. Most items of our products are approved by CE, RoHS,UL, SAA Certificates.



QUALIFIED LIGHTS

Made in KETAI Lighting

Well-equipped apparatus and instruments, and strict quality control throughout all stages of production;

Owning R&D team with 30 experienced qualified engineers;

5-10 new items are currently distributed to market every month;

One stop of complete solution for lighting projects;

Unique imagination and designing, advanced developing technologies;

Strict quality parameters conformed with standards.



QUALIFIED SUPPLY CHAIN

CHIPS



DRIVERS



ELECTRICAL COMPONENTS



PRODUCTION PROCESS

Thanks to our perfect PMC system, production system and strict quality control system with perfect inspection process.

All new products undergoes stringent validation and age testing prior to production.

All products undergoes "burn in" test prior to packing.

All orders are QC inspected by our staff prior to shipping.

All products in mentioned have independent certified to meet customer's need.

Global Excellence Made in KETAI Lighting

We have 500 employees, our greatest advantage is to design, develop and produce the special, creative, high-tech LED lights. No matter what kinds of LED lights you want, just tell us your demand. The best solution would be provided by our professional engineers, our well experienced 30 engineers in the R&D dept. customize available solutions for various lighting projects, free design drawing can be provided according to customer's demand.

We are ISO 9001 certified manufacturer. Most items of our products are approved by CE, RoHS, SAA etc. certificates.

We are keeping on running with the vision focusing on service, education, brand and technology support. With 20 years of practice and experience, Ketai lighting is getting a good reputation in commercial lighting industry in the world and has an extensive sales network.





Lighting Solution Made in KETAI Lighting

Thanks for our unique and creative design, our product is introduced in mainly application, from large residential or public buildings to commercial, institutional or public spaces.

BAR & RESTAURANT



OFFICE



RETAIL & SHOPPING MALL

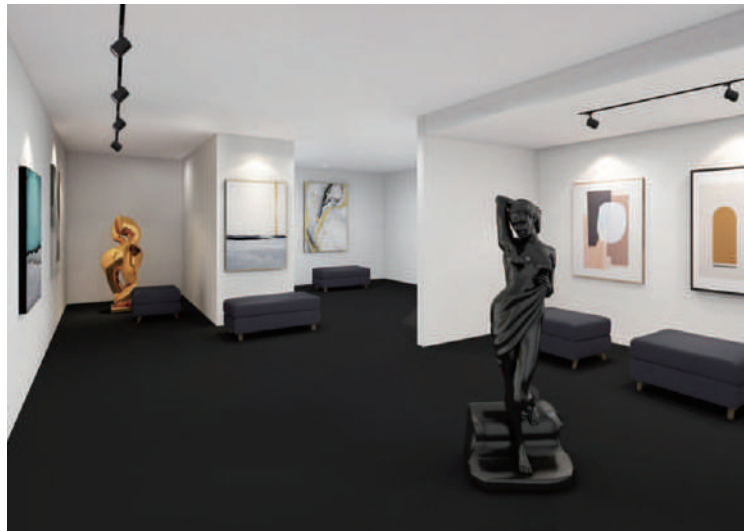

GALLERY

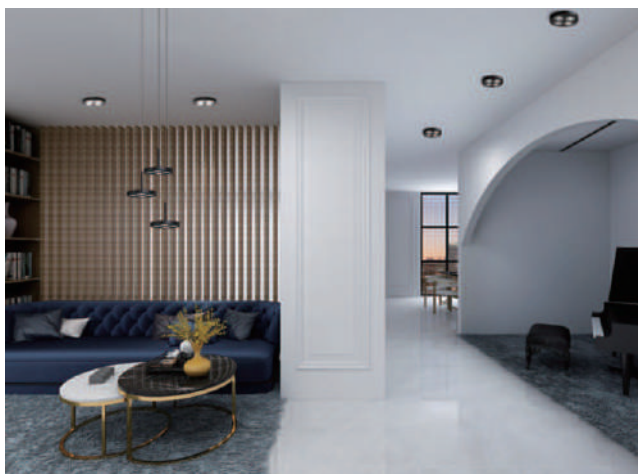

RESIDENTIAL

Lighting Completeness Made in KETAI Lighting

We are ISO9001 certified manufacturer and most of our products are approved by CE, CB, UL, SAA, GS, TUV and CCC certifications. The quality of our products is assured by our implementing QS ERP system and well-equipped testing lab. With more than 20 years experience in lighting fixtures exporting field, our market has covered Europe South America, Mid-East and Russia.

The R&D Department has 30 engineers and they independently research and develop new products each year.

Our engineers have the comprehensive ability of structure development, optical design, thermal design to meet customers' various demands.

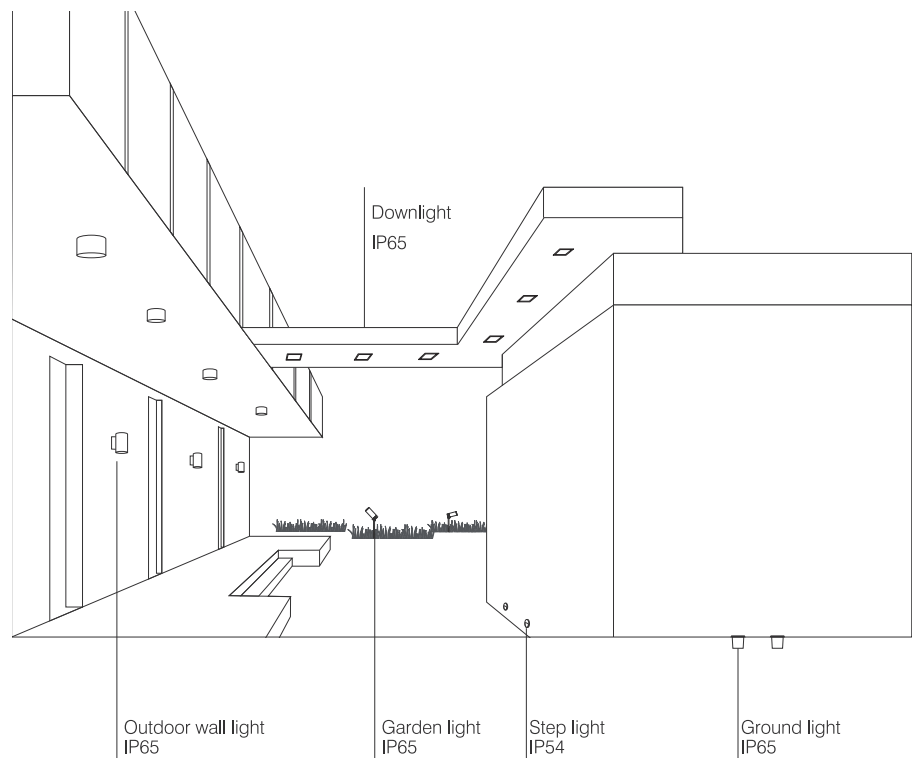

Ketai Lighting is a commercial lighting manufacturer specialized in a diverse range of interior light with exterior light. The product range covers LED recessed downlight, LED track light, LED ceiling light, LED wall light, LED magnetic light system and LED outdoor light.

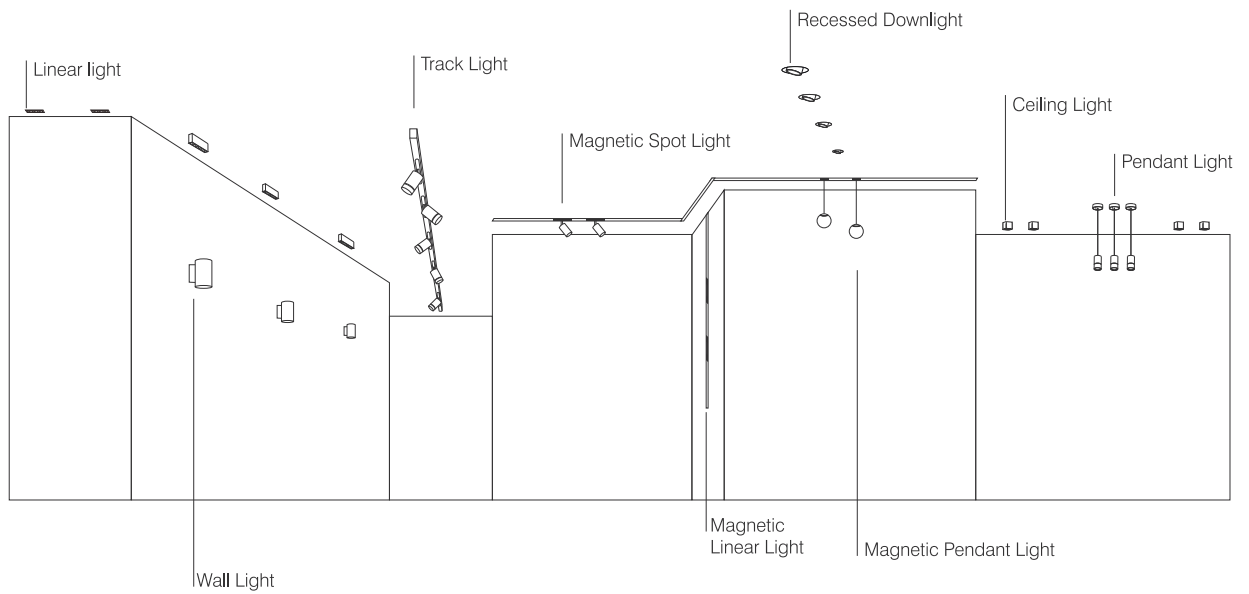

Value Added Service Made in KETAI Lighting

The greatest advantage of ours is to design, develop and produce the special, creative, high-tech LED lights. No matter what kinds of LED lights you like, just tell us your demand, the best solution would be provided by our professional engineers, 30 well experienced engineers in the R&D dept. And also we customize available tailored solutions for various lighting projects.

Using what we have learned and accumulated experience, we are constantly moving forward and creating new concepts. This proprietary technology allows us to tailor our customers.

Tailor-made is an alternative solution, which means

- 1) customizing the size of the luminaire according to the size of the area used;
- 2) maintaining the color of the luminaire in harmony with the overall color of the area used and the surrounding environment;
- 3) design style of the luminaire to meet the needs of the decoration style of the use of the regional space;
- 4) the performance of the luminaire meeting the needs of specific application scenarios, such as waterproof, moisture-proof and corrosion-resistant.



Photograph in Guangdong Dagan Museum

Index



1 LENS



KT7060 / KT7061 / KT7062
P3



4 LESS PLUS



KT7070 / KT7071 / KT7072
KT7073 / KT7074 / KT7075
P7



8 CANEO



KT7063 / KT7064
P11



KT7063A / KT7064A
P12



KT7063B / KT7064B
P13



14 NOVEL



WL635
P17



WL636
P17



MHT8888 / MHT8889
P18



WL633 / WL640
P19



WL634
P20

LENS

- 5 years warranty.
- Good quality of power coating process.
- Material is conducive to heat dissipation of products,which ensures the life.



LENS



KT7061 15W
KT7060 20W
KT7062 34W

- Lower UGR < 16
- High lumen output, high efficient lens.
- LENS optics exchangeable: oval, uniform and high intensity.

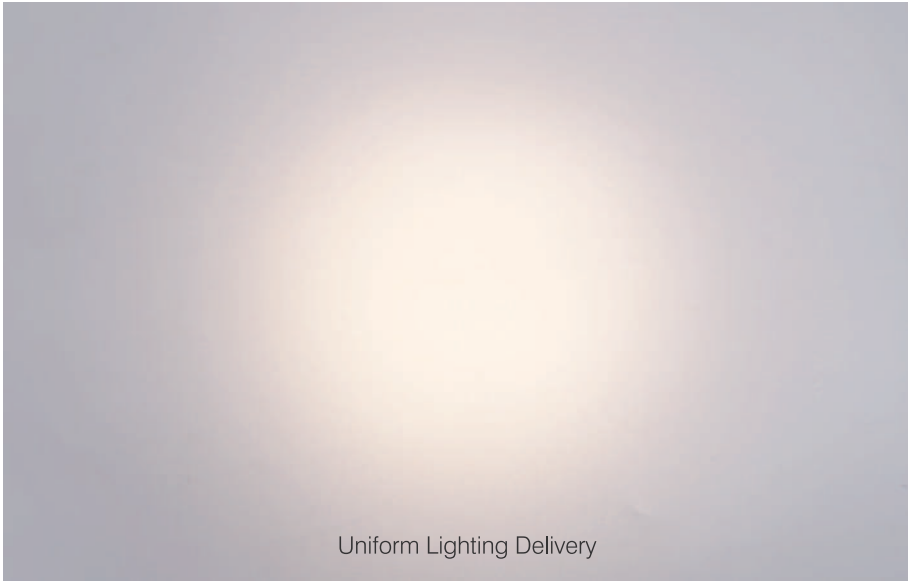

Uniform Lighting Delivery

RECESSED DOWNLIGHT



LENS FAMILY FIXED DOWNLIGHT

TECH. DRAWING



LENS FAMILY

LED  220-240 V IP20 CITIZEN OSRAM

	W	LUM	CCT	BEAM	CRI	DIA	H	CUTOUT
KT7060	20	1800	3000K	33°	80	Φ110mm	81mm	Φ95mm
KT7061	15	1300	3000K	33°	80	Φ95mm	71mm	Φ80mm
KT7062	30	2480	3000K	24°	80	Φ135mm	95mm	Φ120mm

OPTIONS

Color RAL 9016 RAL 9006 RAL 9005
 Beam Angle^{KT7060} 17° 23° 33° 43°
 Beam Angle^{KT7061} 15° 21° 33° 37° 43° 55° 59°
 Beam Angle^{KT7062} 16° 24° 31° 36°
 CCT 2700K 3000K 4000K
 CRI 80 90

SOURCE OPTION /

DRIVER OPTION /

REFERENCE DRAWING

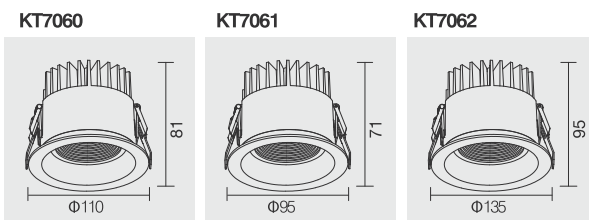

LESS PLUS



LESS PLUS



- 5 years warranty.
- Good quality of power coating process.
- Material is conducive to heat dissipation of products, which ensures the life.



LESS PLUS

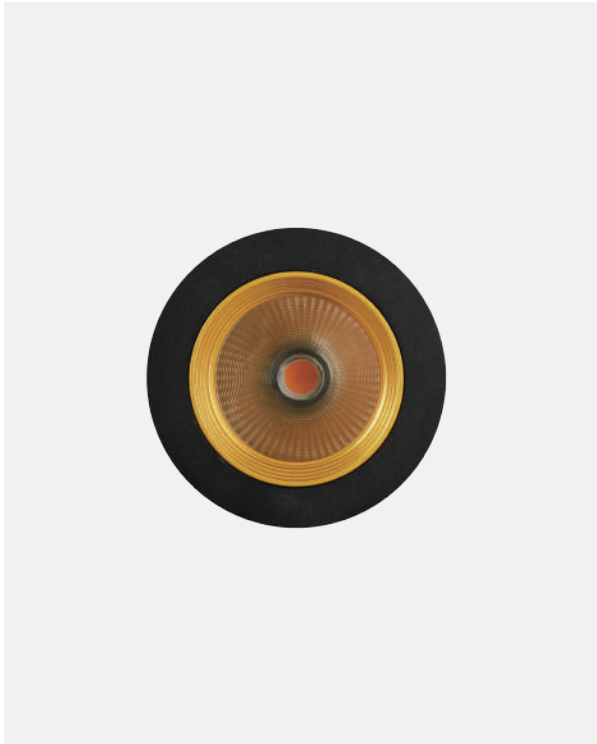

- UL approval
- Deep anti-glare
- 6 sizes: 3W, 5W, 8W, 12W, 18W and 30W to satisfy different lighting scenes
- Different beam angle 15° / 24° / 38° / 55° for option
- Step-type front ring color gold and white and black for selection



KT7073 12W
KT7074 20W
KT7075 25W

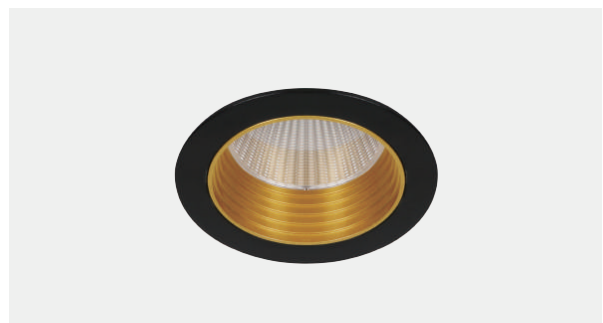

KT7070 3W
KT7071 5W
KT7072 8W

RECESSED DOWNLIGHT



LESS PLUS FAMILY FIXED DOWNLIGHT

TECH. DRAWING

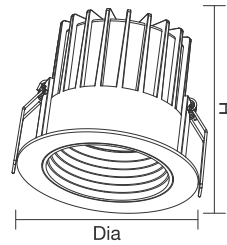

LESS PLUS FAMILY

LED 220-240 V IP20 Bridgelux KEGU

	W	LUM	CCT	BEAM	CRI	DIA	H	CUTOUT
KT7070	3	241	3000K	45°	80	Φ45mm	35mm	Φ35mm
KT7071	5	285	3000K	24°	80	Φ55mm	55mm	Φ45mm
KT7072	8	496	3000K	20°	80	Φ65mm	55mm	Φ55mm
KT7073	12	862	3000K	25°	80	Φ75mm	65mm	Φ65mm
KT7074	20	1591	3000K	24°	80	Φ105mm	86mm	Φ95mm
KT7075	25	2466	3000K	24°	80	Φ115mm	93mm	Φ105mm

OPTIONS

Color RAL 9016 RAL 9006 RAL 9005
 Beam Angle 20° 40° 60°
 Beam Angle 15° 25° 38° 60°
 Beam Angle 15° 24° 38°
 Beam Angle 15° 24° 38° 55°
 CCT 2700K 3000K 4000K
 CRI 80 90

REFERENCE DRAWING

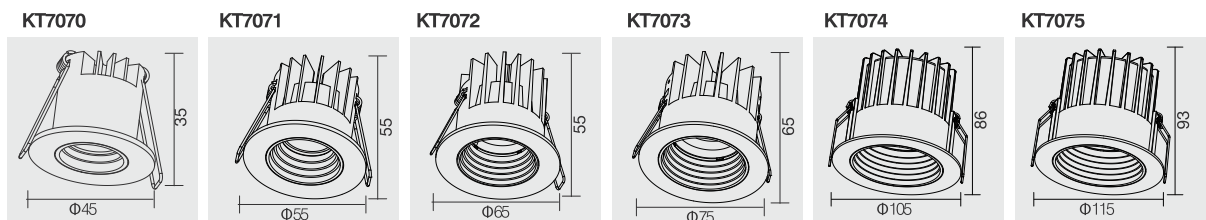

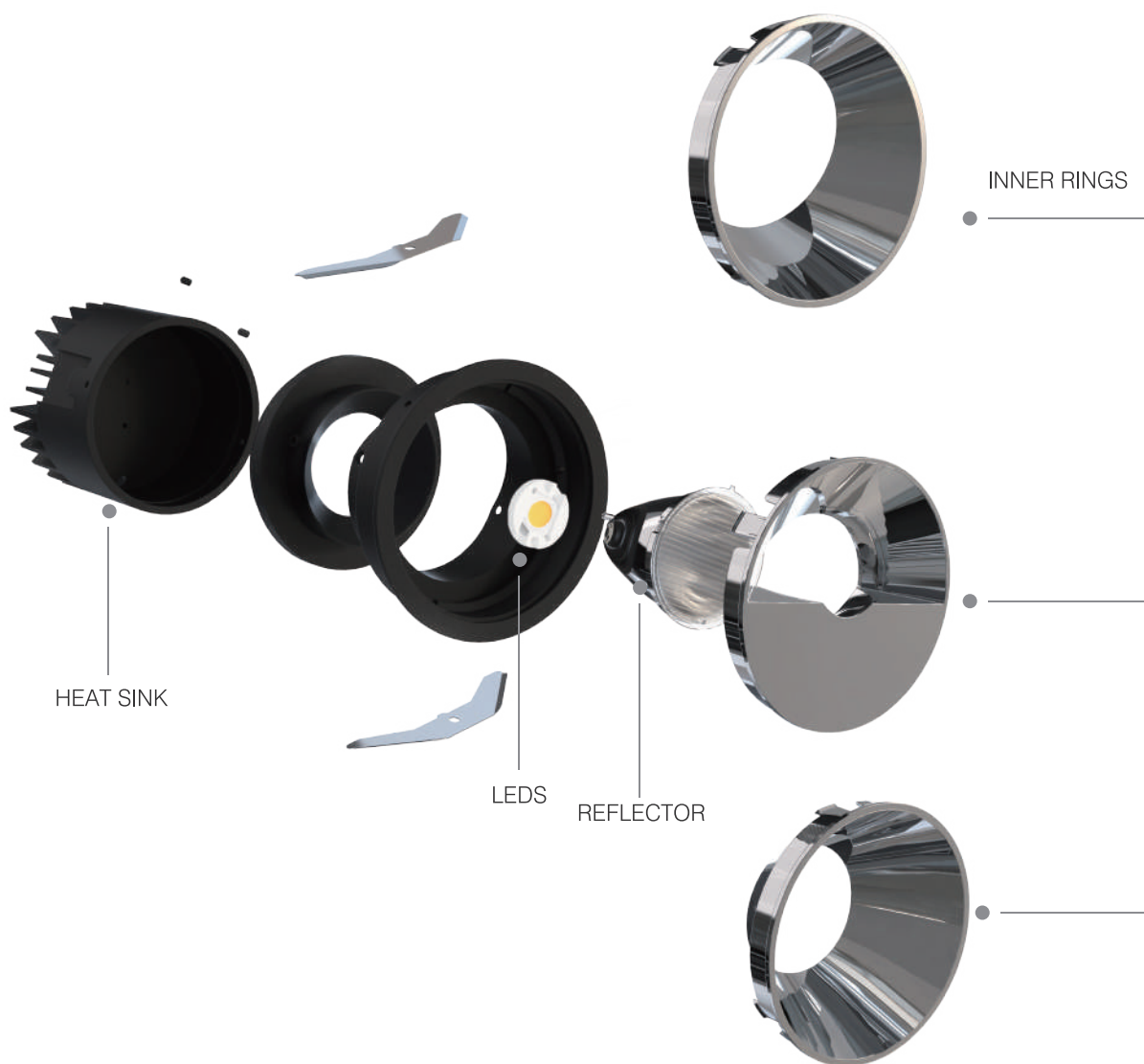

Match different inner rings

CANEO

- Deep anti-glare UGR<16
- Optics reflector for option: wall washer, adjustable and downlight
- 2 size: 15W and 20W



KT7063 20W



White

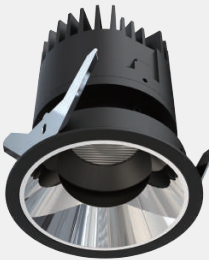

KT7063B 20W
KT7064B 15W



White

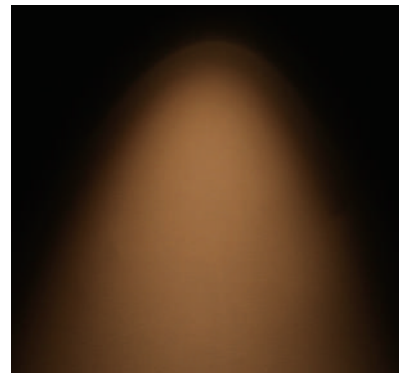

KT7063A 20W
KT7064A 15W



White

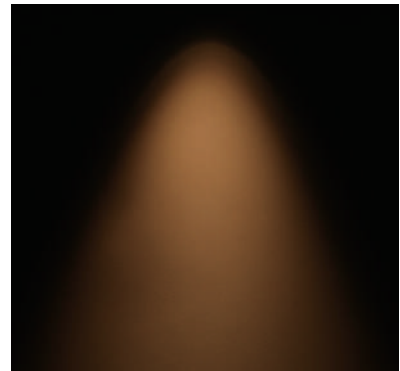



- Different inner rings are used in combination, produces the different lighting effect.



RECESSED DOWNLIGHT



CANEO FAMILY FIXED DOWNLIGHT

TECH. DRAWING

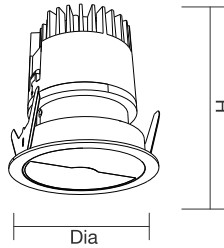

CANEO FAMILY

LED  220-240 V IP20 **KT7063** CITIZEN **KT7064** Bridgelux OSRAM

	W	LUM	CCT	BEAM	CRI	DIA	H	CUTOUT
KT7063	20	1180	3000K	23°	80	Φ110mm	121mm	Φ100mm
KT7064	15	610	3000K	25°	80	Φ90mm	102mm	Φ80mm

OPTIONS

- Color RAL 9016 RAL 9006 RAL 9005
- Beam Angle **KT7063** 18° 23° 36°
- Beam Angle **KT7064** 18° 25° 35°
- CCT 2700K 3000K 4000K
- CRI 80 90

SOURCE OPTION

/

DRIVER OPTION

/

REFERENCE DRAWING

KT7063

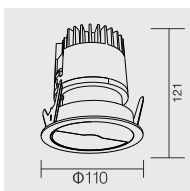

KT7064

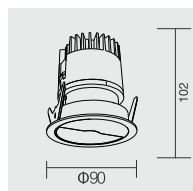

RECESSED DOWNLIGHT



CANEO FAMILY TILTABLE DOWNLIGHT

TECH. DRAWING

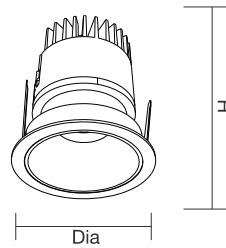

CANEO FAMILY

LED  220-240 V IP20 **KT7063A** CITIZEN **KT7064A** Bridgelux OSRAM

	W	LUM	CCT	BEAM	CRI	DIA	H	CUTOUT
KT7063A	20	1740	3000K	23°	80	Φ110mm	121mm	Φ100mm
KT7064A	15	970	3000K	25°	80	Φ90mm	102mm	Φ80mm

OPTIONS

Color RAL 9016 RAL 9006 RAL 9005
 Beam Angle 18° 23° 36°
 Beam Angle 18° 25° 35°
 CCT 2700K 3000K 4000K
 CRI 80 90

SOURCE OPTION /

DRIVER OPTION /

REFERENCE DRAWING

KT7063A

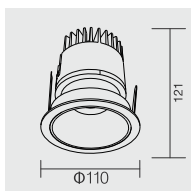

KT7064A

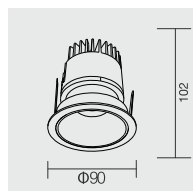

RECESSED DOWNLIGHT

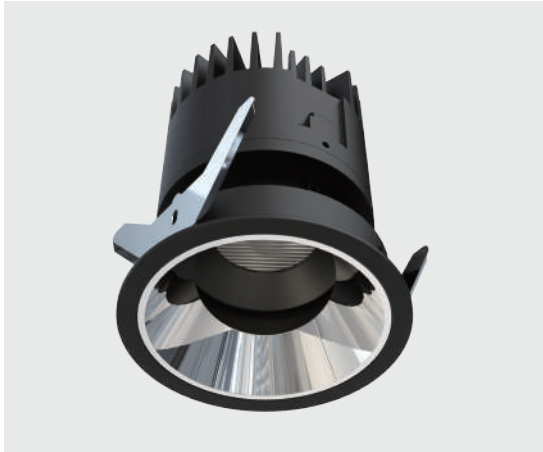

CANEO FAMILY FIXED DOWNLIGHT

TECH. DRAWING

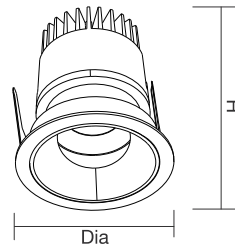

CANEO FAMILY

LED  220-240 V IP20 **KT7063B** CITIZEN **KT7064B** Bridgelux OSARM

	W	LUM	CCT	BEAM	CRI	DIA	H	CUTOUT
KT7063B	20	1940	3000K	23°	80	Φ110mm	121mm	Φ100mm
KT7064B	15	1020	3000K	25°	80	Φ90mm	102mm	Φ80mm

OPTIONS

Color RAL 9016 RAL 9006 RAL 9005

Beam Angle 18° 23° 36°

Beam Angle 18° 25° 35°

CCT 2700K 3000K 4000K

CRI 80 90

SOURCE OPTION /

DRIVER OPTION /

REFERENCE DRAWING

KT7063B

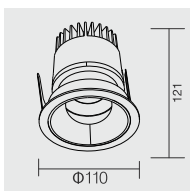

KT7064B

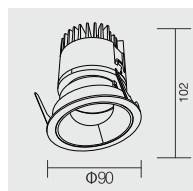

NOVEL



NOVEL



- 5 years warranty.
- Good quality of power coating process.
- Material is conducive to heat dissipation of products, which ensures the life.

NOVEL



WL634 26W



WL640 15W

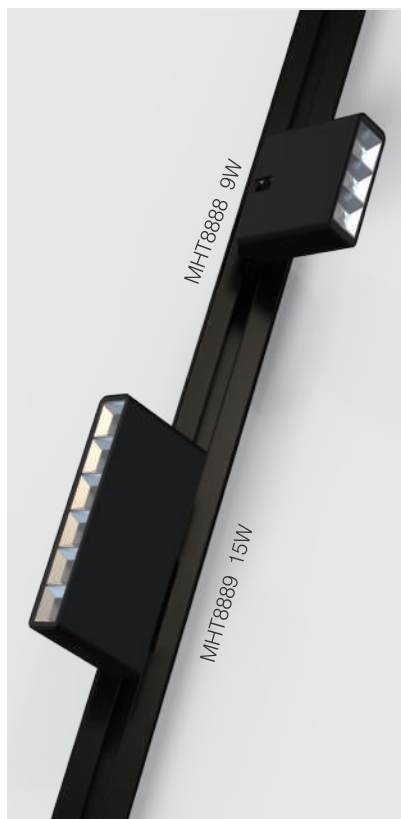

MHT8888 9W

MHT8889 15W



WL633 16W



WL635 16W



WL636 9W

- Book-shaped housing and applied in wall light and track light
- Wall light IP65 rating and track light IP20
- Beam angle 12° / 34° / 48° for selection

OUTDOOR LIGHT



LED  220-240 V  IP65  CREE  OSRAM

	W	LUM	CCT	BEAM	CRI
WL635	16	720	3000K	34°	80

NOVEL WATERPROOF UP & DOWN WALL LIGHT

OPTIONS

Color	<input type="radio"/> RAL 9016	<input type="radio"/> RAL 9006	<input type="radio"/> RAL 9005
Beam Angle	<input type="radio"/> 12°	<input type="radio"/> 34°	<input type="radio"/> 48°
CCT	<input type="radio"/> 2700K	<input type="radio"/> 3000K	<input type="radio"/> 4000K
CRI	<input type="radio"/> 80	<input type="radio"/> 90	

SOURCE OPTION /

DRIVER OPTION /

TECH. DRAWING size in mm

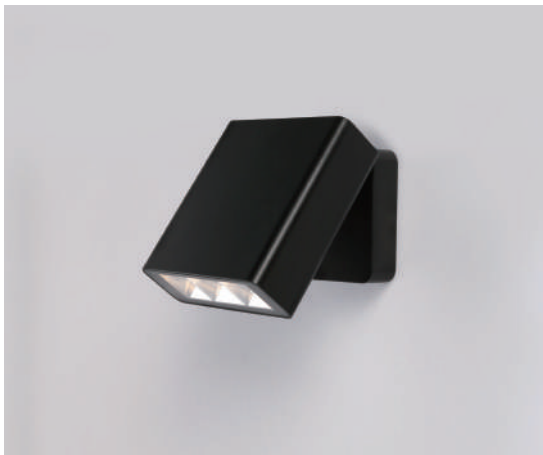
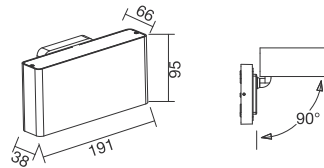

LED  220-240 V  IP65  CREE  OSRAM

	W	LUM	CCT	BEAM	CRI
WL636	9	380	3000K	34°	80

NOVEL WATERPROOF UP & DOWN WALL LIGHT

OPTIONS

Color	<input type="radio"/> RAL 9016	<input type="radio"/> RAL 9006	<input type="radio"/> RAL 9005
Beam Angle	<input type="radio"/> 12°	<input type="radio"/> 34°	<input type="radio"/> 48°
CCT	<input type="radio"/> 2700K	<input type="radio"/> 3000K	<input type="radio"/> 4000K
CRI	<input type="radio"/> 80	<input type="radio"/> 90	

SOURCE OPTION /

DRIVER OPTION /

TECH. DRAWING size in mm

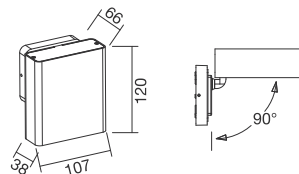

TRACK LIGHT



NOVEL TILTABLE & ROTATABLE TRACK LIGHT

OPTIONS

Color	<input type="radio"/> RAL 9016	<input type="radio"/> RAL 9006	<input type="radio"/> RAL 9005
Beam Angle	<input type="radio"/> 12°	<input type="radio"/> 34°	<input type="radio"/> 48°
CCT	<input type="radio"/> 2700K	<input type="radio"/> 3000K	<input type="radio"/> 4000K
CRI	<input type="radio"/> 80	<input type="radio"/> 90	

SOURCE OPTION /

DRIVER OPTION /

LED  220-240 V IP20 CREE KEGU

	W	LUM	CCT	BEAM	CRI
MHT8888	9	300	3000K	34°	80

TECH. DRAWING size in mm

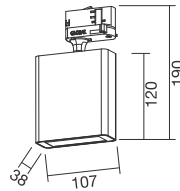

NOVEL TILTABLE & ROTATABLE TRACK LIGHT

OPTIONS

Color	<input type="radio"/> RAL 9016	<input type="radio"/> RAL 9006	<input type="radio"/> RAL 9005
Beam Angle	<input type="radio"/> 12°	<input type="radio"/> 34°	<input type="radio"/> 48°
CCT	<input type="radio"/> 2700K	<input type="radio"/> 3000K	<input type="radio"/> 4000K
CRI	<input type="radio"/> 80	<input type="radio"/> 90	

SOURCE OPTION /

DRIVER OPTION /

LED  220-240 V IP20 CREE KEGU

	W	LUM	CCT	BEAM	CRI
MHT8889	15	680	3000K	34°	80

TECH. DRAWING size in mm

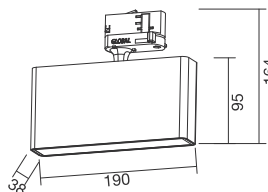

OUTDOOR LIGHT



LED  220-240 V  IP65  CREE  KEGU

	W	LUM	CCT	BEAM	CRI
WL633	16	625	3000K	34°	80

NOVEL WATERPROOF UP & DOWN WALL LIGHT

OPTIONS

Color RAL 9016 RAL 9006 RAL 9005
 Beam Angle 12° 34° 48°
 CCT 2700K 3000K 4000K
 CRI 80 90

SOURCE OPTION /

DRIVER OPTION /

TECH. DRAWING size in mm

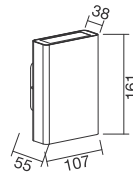

LED  220-240 V  IP65  CREE  KEGU

	W	LUM	CCT	BEAM	CRI
WL640	15	670	3000K	34°	80

NOVEL WATERPROOF UP & DOWN WALL LIGHT

OPTIONS

Color RAL 9016 RAL 9006 RAL 9005
 Beam Angle 12° 34° 48°
 CCT 2700K 3000K 4000K
 CRI 80 90

SOURCE OPTION /

DRIVER OPTION /

TECH. DRAWING size in mm

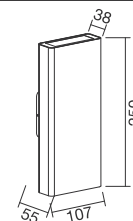

OUTDOOR LIGHT



NOVEL WATERPROOF UP & DOWN WALL LIGHT

OPTIONS

Color	<input type="radio"/> RAL 9016	<input type="radio"/> RAL 9006	<input type="radio"/> RAL 9005
Beam Angle	<input type="radio"/> 12°	<input type="radio"/> 20°	<input type="radio"/> 34° <input type="radio"/> 48°
CCT	<input type="radio"/> 2700K	<input type="radio"/> 3000K	<input type="radio"/> 4000K
CRI	<input type="radio"/> 80	<input type="radio"/> 90	

SOURCE OPTION /

DRIVER OPTION /

LED  220-240 V IP65 CREE KEGU

TECH. DRAWING size in mm

	W	LUM	CCT	BEAM	CRI
WL634	26	1340	3000K	34°	80

