

KETAI

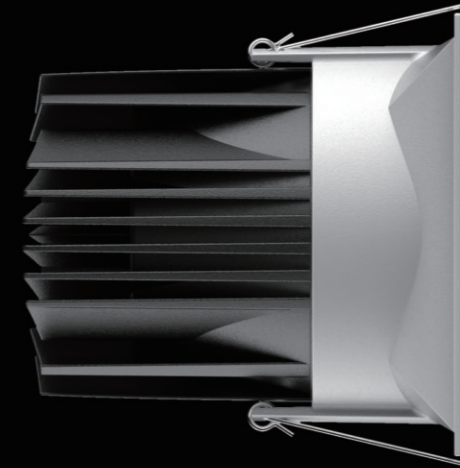

JOIN US

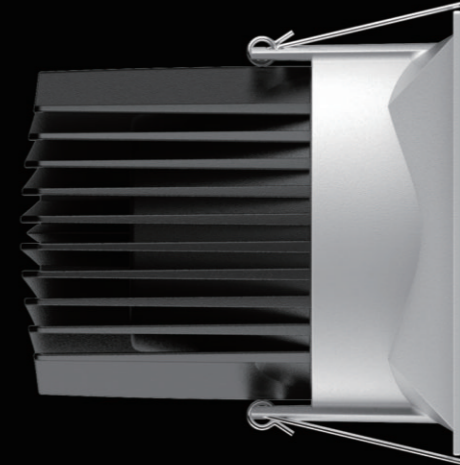
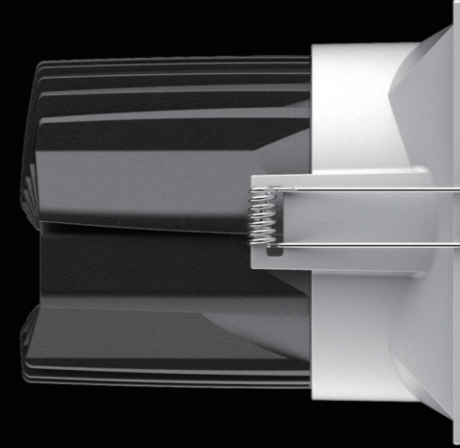

WHAT WE OFFER



A LARGE VARIETY OF LIGHTING FIXTURES ALL IN KETAI

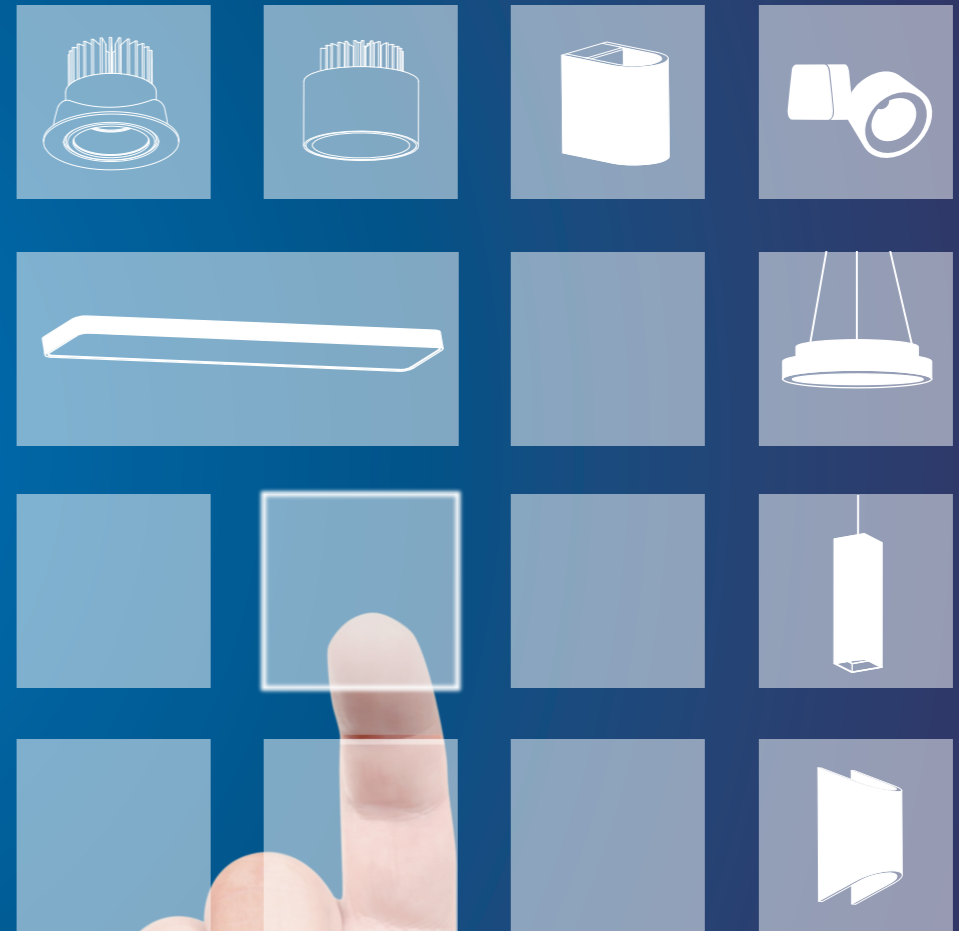

WHO ARE WE

WE LOVE TO WORK & WE LOVE WHERE WE WORK



Ketai Industries Lighting Co.,Ltd. was set up in 1999 by brothers Daniel and David, focusing on development and production of the top level commercial lighting products, and having developed thousands of interior and exterior lighting fixtures, including all kinds of led downlights, led wall light, track lights, pendant lights, offering you one stop solution of lighting project.

We currently have over 40000 square meters standard industrial production buildings and more than 500 professional staff. Our annual turnover has been over 30 million USD. And we have set up our own R & D centre and have our own aluminium alloy die-casting, metal surface spraying, mould processing, metal pressing LED electronic processing and end product assembling factories and can offer unique design and production service to our clients.

We are ISO9001 certified manufacturer and most of our products are approved by CE, CB, UL, SAA, GS, TUV and CCC certifications. The quality of our products is assured by our implementing QS ERP system and well-equipped testing lab. With more than 18 years experience in lighting fixture exporting field, our market has covered Europe South America, Mid-East and Russia. The R&D Department has 20 engineers and they independently research and develop new products each year. Our engineers have the comprehensive ability of structure development, optical design, thermal design to meet customers' various demands.

- 18 years' experience in lighting industry;
- 500 employees;
- 40k sqm fully owned factory;
- 20 R&D engineers;
- 20 professional and well experienced sales team to easy your order;
- The production status report every week as your request;
- 40 IQC & FQC / 10 QA team to assurance your products' quality;
- ISO 9001, ERP system, professional QC system, CE, ROHS, SAA certificates.
- Well equipped laboratory,
- Top level of organization, production, customer service and marketing;
- Very well equipped production lines: 26 sets of punching machines, 2 painting lines, series of CNC machines and others;
- 30 million USD export turnout every year.

Learn more, please visit our website >> www.ketailighting.com

HISTORY OF COMPANY DEVELOPMENT

Ketai Industries Lighting Manufacturer Professional in Commercial LED Lighting



MANUFACTURING PROCESS

Ketai Industries Lighting Manufacturer Professional in Commercial LED Lighting

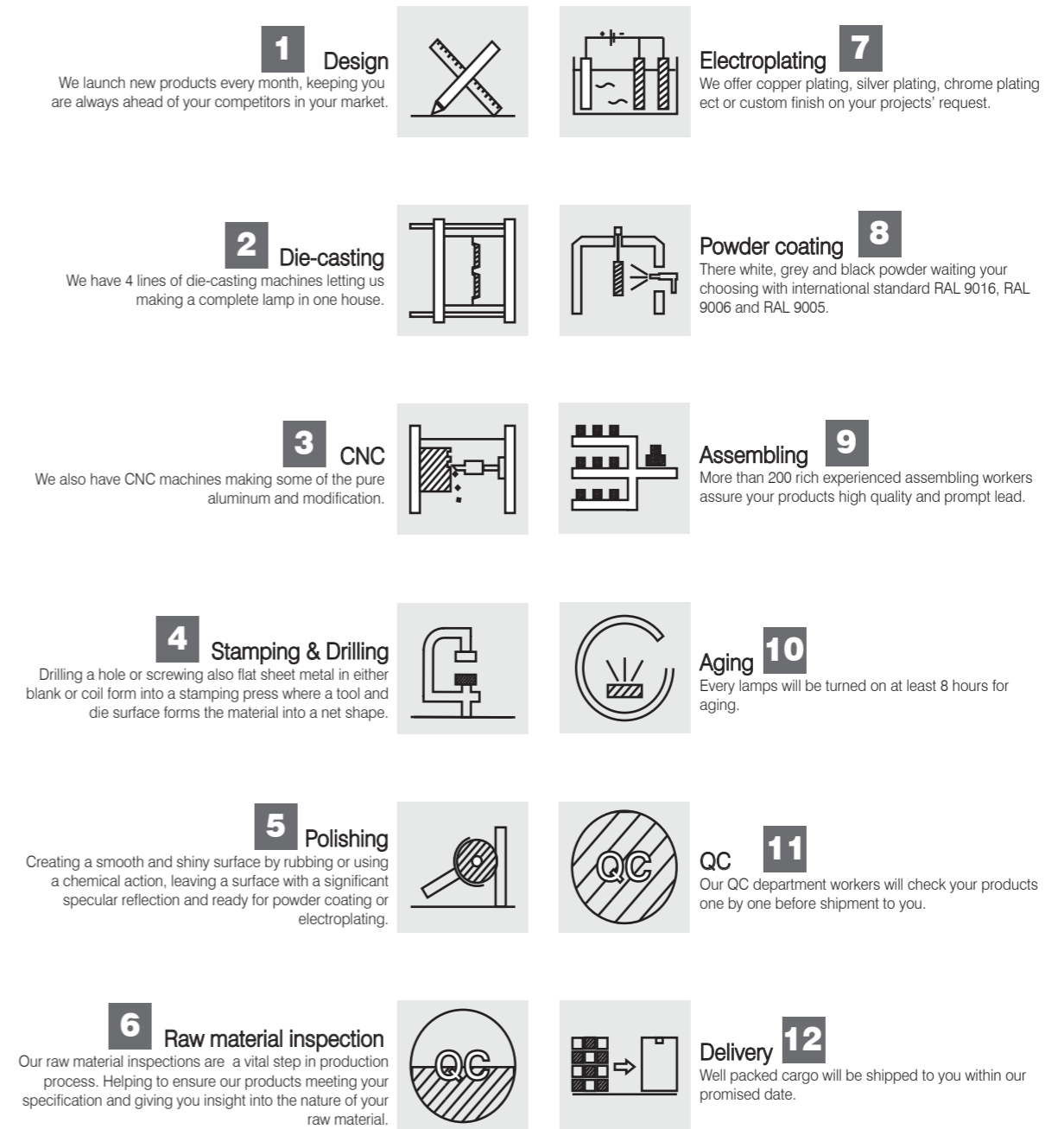

LED HEAT SINK

EXTRUSIONS BENEFITS

- Moderate to high surface area;
- Machinable;
- Available in any length;
- Hundreds of standard profiles.

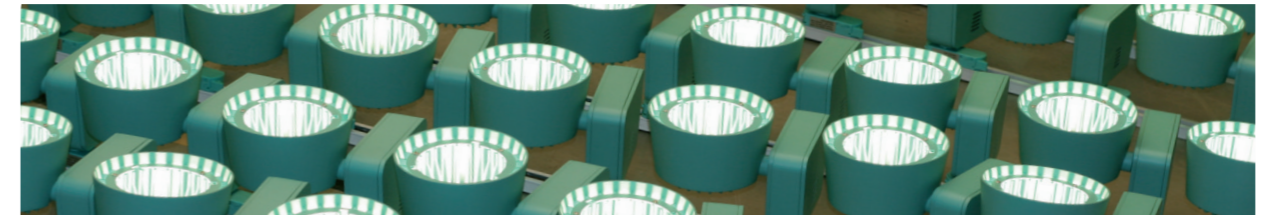

EXTRUSIONS ALUMINUM

A billet of aluminum is heated to temperatures in excess of 900°F. Next, the billet is pressed and drawn through a die of the desired cross section by a rod with up to 22 tons of force.

The extrusion is then manually pulled through the opposite end and cooled. In the final stage, the extrusion is cut to the requested length.

At this point secondary processes are then performed.

TOOLING COST

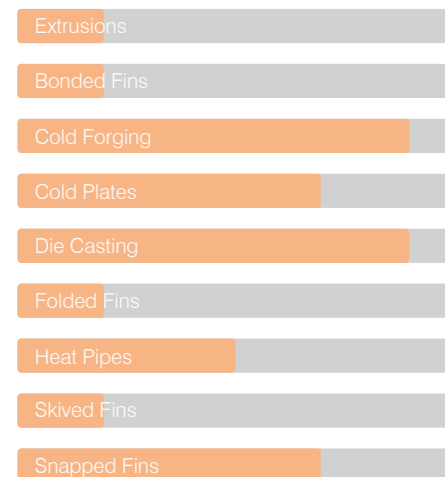

PRODUCTION COST

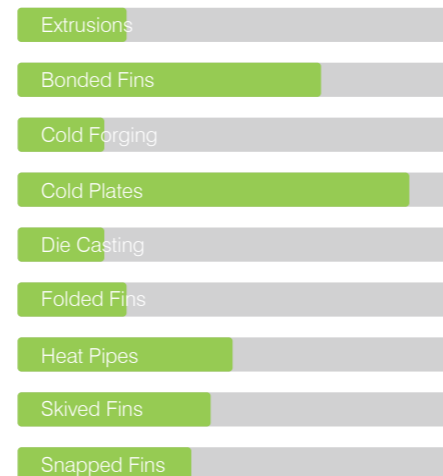

DIE-CASTING BENEFITS

- Complex shapes;
- Single manufacturing step;
- Durable & rigid;
- Minimal secondary processes;
- Detailed surface.

ALUMINUM DIE-CASTING

Die casting is the manufacturing process of injecting liquid molten metal under high pressure into a high precision mold. It is often used to mass produce complex three-dimensional structures with a detailed surface texture.

This is done within a single manufacturing step without post treatment. The surface of the die is quickly cooled by the mold and the slowly cooling core creates a negative pressure within the cast metal, which in turn makes it more rigid and increases its structural integrity.

THE LANGUAGE OF LIGHTING

Wattage, CRI, CCT, Lumen, Beam angle and UGR these are the important factors which effect the lighting environment. Different combination of these factors will create quite different lighting quality we are living.



TRIDONIC

CITIZEN CREE  bridgeLux  NICHIA LUMENS

WHICH LED CHIP WE USE

As we know, LED sources is very important for lighting quality, so we pay more attention on LED sources selection. Like TRIDONIC, CITIZEN, CREE, BRIDGELUX, NICHIA & LUMENS are all our company's great partners.

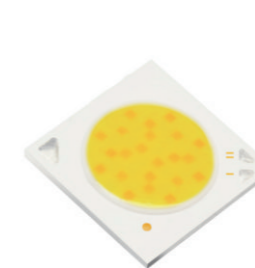

DIM2Warm



COB

POWER DRIVER & CONTROL SYSTEM

A COMPLIANT WITH HEALTH NORMS

Tridonic ripple free LED drivers (<3%) ensure the lowest level of light flickering. In low and higher output levels, the flickering is reduced to a level, imperceptible for the human eye. However surveys have proven a relation between flickering and health problems. Therefore, the application of lighting systems with a lower flicker index is an important factor in both commercial and residential areas.

B LONGER LIFETIME

In addition to negative effects for human health high ripple current will hamper the LED, the LED driver and the efficiency of the system in general.

C VIDEO/PHOTO PROOF

Lighting with a low flickering index is essential in areas where photo and video cameras are used. Flickering light sources have a negative effect on the quality of photos and video footage.

D SURGE PROTECTION

The Tridonic drivers are protected against surges up to 4kV. This is well above the norm of 1kV. Many LED businesses are protected up to 500V. The surge protection level of the Tridonic drivers results in an extremely low defect rate of around 0.1%.

E HIGHER LIGHT OUTPUT

A LED driver with a lower ripple factor is 5% more efficient in terms of light output.

F RIPPLE FREE

Tridonic LED drivers are provided with a sophisticated multistage circuit to supply the LEDs with a perfect current (a line). Low quality drivers with a poor ripple factor may cause problems including headache, eye strain, impaired visual performance or, in extreme cases, epileptic seizure.

G SAFETY AND SECURITY

Excessive heat / short circuit protection protection against voltage spikes in the electricity net overload protection.



PHILIPS

TRIDONIC

enlightening your ideas

OSRAM

HEP power for light™

AREEK



FEATURES & BENEFITS

- SURGE PROTECTED UP TO 4KV
- VARIOUS DIMMING OPTIONS (1-10V, PUSH, DALI)
- MULTIPLE OUTPUT CURRENT OPTIONS THROUGH DIP SWITCH SETTINGS
- HEAT GENERATION AT FULL LOAD STAYS WELL BELOW THE ALLOWED MAX. 70° C (TC)
- UPCOMING VERSIONS WITH BLUETOOTH LOW ENERGY COMPATIBILITY
- ENEC/EMC COMPLIANT
- STRAIN RELIEF IN ACCORDANCE WITH EUROPEAN SAFETY STANDARDS
- ACTIVE POWER FACTOR (PF) CORRECTION
- HIGHEST QUALITY A - BRAND ELECTRONIC COMPONENTS

WHO WE SELL

Want to grow your lighting business faster
Be our partner now !

Each country, Ketai sells only to one distributor. We are focus on business partnership. if you are professional in lighting market and looking for a reliable supplier from China. Then we are the one.

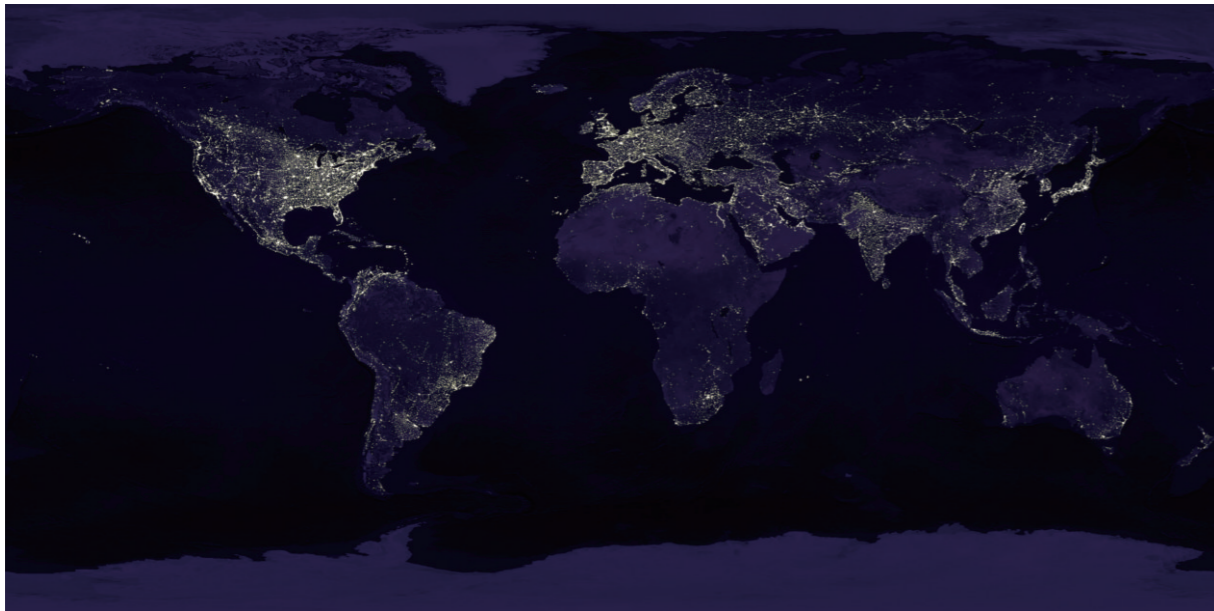

3 WAYS OF BEING OUR PARTNER

1. Be our "ketai" brand exclusive distributor in your region
2. Be our OEM exclusive distributor, but print "manufactured by ketai" on the color box
3. Just be our ODM exclusive distributor in your region

KETAI

DOWN LIGHT  A01-A102

TRACK LIGHT  B01-B34

CEILING LIGHT  C01-C36

PENDANT LIGHT  D01-D28

WALL LIGHT  E01-E20

OUTDOOR LIGHT  F01-E10

INDEX

DOWN LIGHT

KT16-1	A87
KT16-2	A87
KT16-3	A87
FT210	A75
FT210C	A75
FT211	A76
FT211C	A76
KT6309	A53
KT6327	A54
KT6344-1	A65
KT6344-2	A66
KT6347	A63
KT6347B	A64
KT6355	A67
KT6355A	A68
KT6550	A41
KT6551	A42
KT6554	A31
KT6560-1	A43
KT6560-2	A44
KT6564	A49
KT6565	A50
KT6564A	A47
KT6565A	A48
KT6566	A101
KT6567-1	A51
KT6567-2	A52
KT6574	A55
KT6577	A99
KT6578	A100
KT6580	A56
KT6583-1	A57
KT6583-2	A58
KT6585-1	A61
KT6585-2	A62
KT6594	A21
KT6595	A38
KT6594A	A23
KT6596A	A24
H6594F	A16
KT6598	A73
KT6599	A74
KT6613	A71
KT6614	A72
KT6631	A69

DOWN LIGHT

KT6632	A69
KT6633	A69
KT6634	A69
KT6636	A36
KT6647-1	A29
KT6647-2	A30
KT6648-1	A27
KT6648-2	A28
KT6653	A70
KT6654	A70
KT6655	A70
KT6659-1	A25
KT6659-2	A26
KT6662	A32
KT6664	A70
KT6679-1	A85
KT6679-2	A86
KT6696	A80
KT6697	A83
KT6698	A84
KT6808A	A77
KT6808B	A78
KT6808C	A79
KT6814-1	A39
KT6814-2	A40
KT6815	A88
KT6816-1	A89
KT6816-2	A90
KT6817	A91
KT6818	A92
KT6821	A45
KT6822	A46
KT6826	A37
KT6827	A98
KT6830	A93
KT6845B	A97
KT6883	A94
KT6884	A95
KT6885	A96
KT6913	A33
KT6914	A34
KT6915	A17
KT6925	A14
KT6926	A14
KT6927	A14

DOWN LIGHT

KT6928	A14
KT6929	A14
KT6930	A14
KT6943	A35
KT6955	A03
KT6956	A04
KT6957	A05
KT6958	A06
KT6967	A11
KT6967-2	A12
KT6968	A15
KT6979	A07
KT6980	A07
KT6981	A07
KT6982	A07
KT6983	A07
KT6984	A07
KT6986	A18
KT6987	A19
KT6988	A20
KT6990	A08
KT7003	A10
KT7004	A09

TRACK LIGHT

HC-8592	B27
HKTA-8592	B27
KTK1-8592	B27
KTK1 8834	B03
KTK1 8835	B03
KTK1 8836	B03
MHT8554	B21
MHT8558	B22
MHT8573	B32
MHT8575	B28
MHT8583	B34
MHT8584	B11
MHT8584H	B12
MHT8584-L20	B13
MHT8584H-L20	B14
MHT8584-L30	B15
MHT8584H-L30	B16
MHT8584-L40	B17
MHT8584H-L40	B18
MHT8585	B19
MHT8585H	B20
MHT8586	B33
MHT8596A	B29
MHT8596B	B30
MHT8597	B31
MHT8830	B07
MHT8831	B08
MHT8837	B05
MHT8847	B05
MHT881	B04

CEILING LIGHT

XD2015	C35
XD2017	C29
XD2018	C30
XD2019	C25
XD2020	C26
XD2022	C18
XD2022A	C17
XD2036-1	C21
XD2036-2	C22
XD2044	C20
XD2045	C20
XD2046	C20
XD2047	C20
XD2048	C14
XD2055A	C15
XD2055B	C16
XD2059	C19
XD2060	C19
XD2061	C19
XD2060	C17
XD2061	C18
XD2065	C33
XD2066	C34
XD2077-1	C31
XD2077-2	C32
XD2078	C23
XD2079	C23
XD2080	C23
XD2081	C28
XD2096	C24
XD2104	C06
XD2106	C27
XD2107	C27
XD2115	C09
XD2121	C10
XD2131	C13
XD2135	C03
XD2136	C04
XD2145	C05
XD2150	C07
XD2151	C11
XD2152	C12
XD2153	C08

PENDANT LIGHT

KF1012A	D28
KF1012B	D28
KF1013	D27
KF1014	D25
KF1015	D17
KF1015A	D18
KF1016	D23
KF1018	D24
KF1019	D19
KF1020	D19
KF1021	D19
KF1022	D19
KF1027	D26
KF1027A	D26
KF1030	D20
KF1031	D20
KF1032A	D12
KF1051	D11
KF1052	D11
KF1053	D11
KF1054	D11
KF1055	D09
KF1056	D07
KF1057	D08
SL362A	D21
SL362B	D21
SL362C	D21
SL363A	D22
SL363B	D22
SL363C	D22
SL367	D15
SL368	D16
SL369	D14
SL370	D03
SL371	D04
SL372	D13
SL373	D13
SL374	D13
SL386	D05
SL388	D06
SL389	D07

WALL LIGHT

WL369	E07
WL369A	E07
WL397A	E12
WL398A	E13
WL536	E14
WL537	E15
WL538	E16
WL541	E08
WL542	E11
WL543	E09
WL544	E17
WL545A	E19
WL545B	E20
WL546	E18
WL572	E18
WL610	E03
WL611	E06
WL612	E04
WL613	E05

OUTDOOR LIGHT

WL558	F06
WL569	F03
WL576	F04
WL577	F05
FL568	F10
FL937	F09

NEW ARRIVAL

LESS



LESS

NEW ARRIVAL



TRIDONIC LESS



Our LESS track lights system are based on simple design. We provide our clients with 15W/ 20W/ 25W/ 30W, 4 wattage options. The LEDs we use are CITIZEN COB version, including drivers. Decades of experience for our valued OEM clients makes us know more about their needs. Simplicity comes from desiners' and engineers' endless effort. It is sophisticated and simple, because we know less is more .



MHT8830 15W/20W
PB07



MHT8831 25W/30W
PB08



XD2135 15W/20W
PC03



XD2136 25W/30W
PC04



SL370 15W/20W
PD03



SL371 25W/30W
PD04

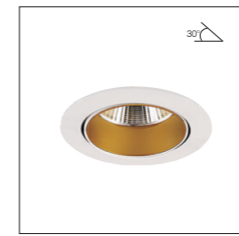

KT6955 15W/20W
PA03

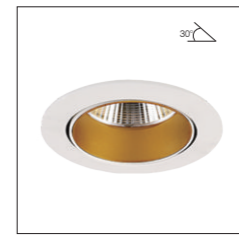

KT6956 25W/30W
PA04



KT6957 15W/20W
PA05



KT6958 25W/30W
PA06

NEW ARRIVAL

OSLO



KTK1 8834 10W P B03

KTK1 8835 15W P B03

KTK1 8836 20W P B03



Our OSLO family are designed special for only you. It is DOB version without driver box attached which make it more slim shape. There are 3 sizes options from 10w to 20w. This family also offer track and surface mounted, two installation options.

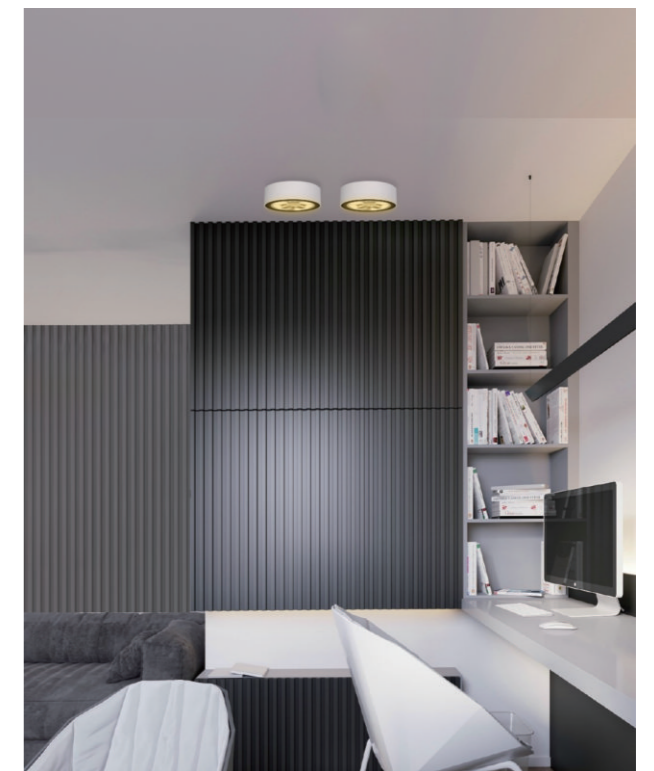

NEW ARRIVAL

MULTIPLE LIGHTS MODULAR

MULTIPLE LIGHTS MODULAR

NEW ARRIVAL

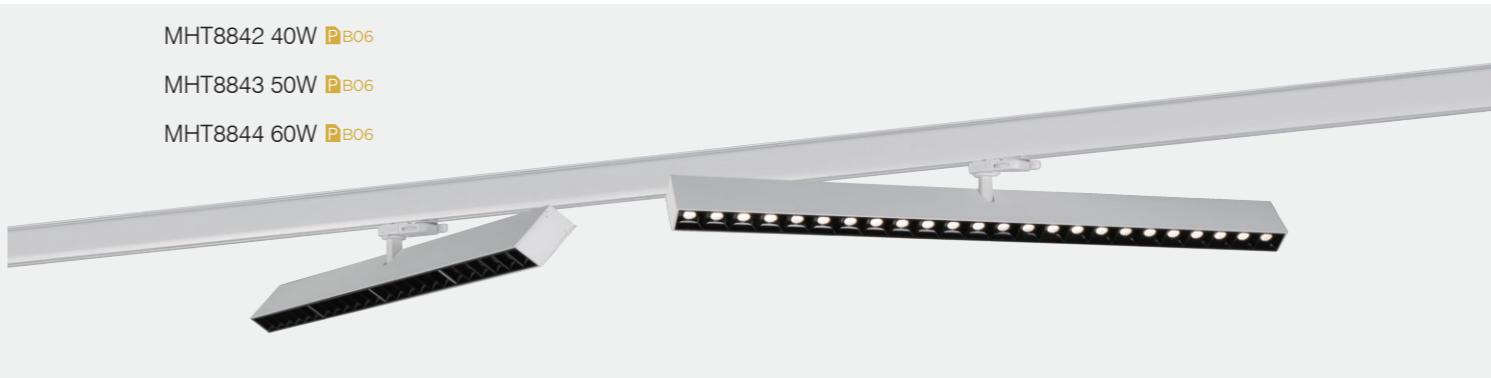

Installation Methods



Customized Length

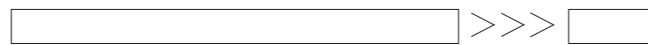

System Options

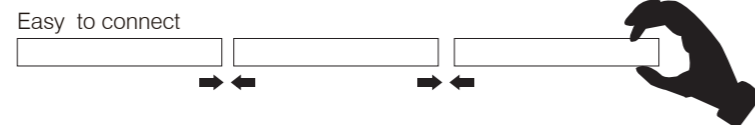

KT6925 / KT6926 / KT6927 / KT6928 / KT6930 SERIES A14

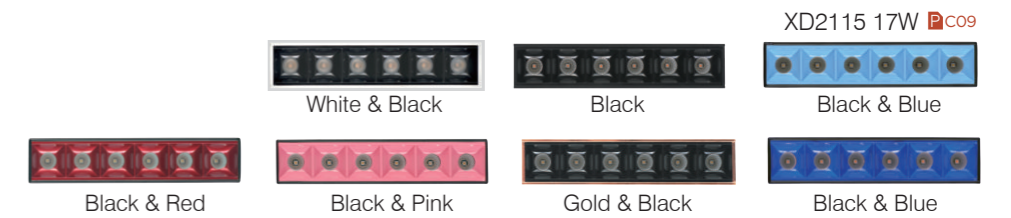



KT6986 32W P A18

KT6986 32W P A18



KT6987 32W P A19

KT6987 32W P A19



KT6988 2X32W P A20

KT6988 2X32W P A20

TAURUS



Now days, people are picky on the lighting environment where they live, in order to attract more business, you always need to change your store decoration often, special the lighting distribution.

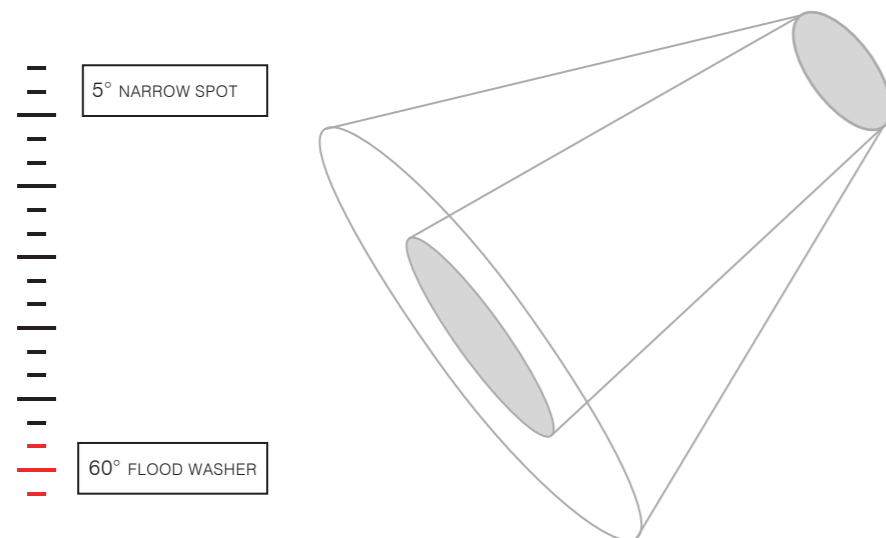

Sometimes from ambient lighting to accent lighting, sometimes revise, which make it difficult to change the different lighting between them. However if you have our TAURUS family, there will be no such problem anymore. Normally is it a flush simple downlights offering ambient lighting, if you need change to accent lighting, just need a simple pull out. They are big power, more than 30w special for higher business space. Our TAURUS includes single head and double heads.

MHT8837 15W  E14MHT8847 30W  E27

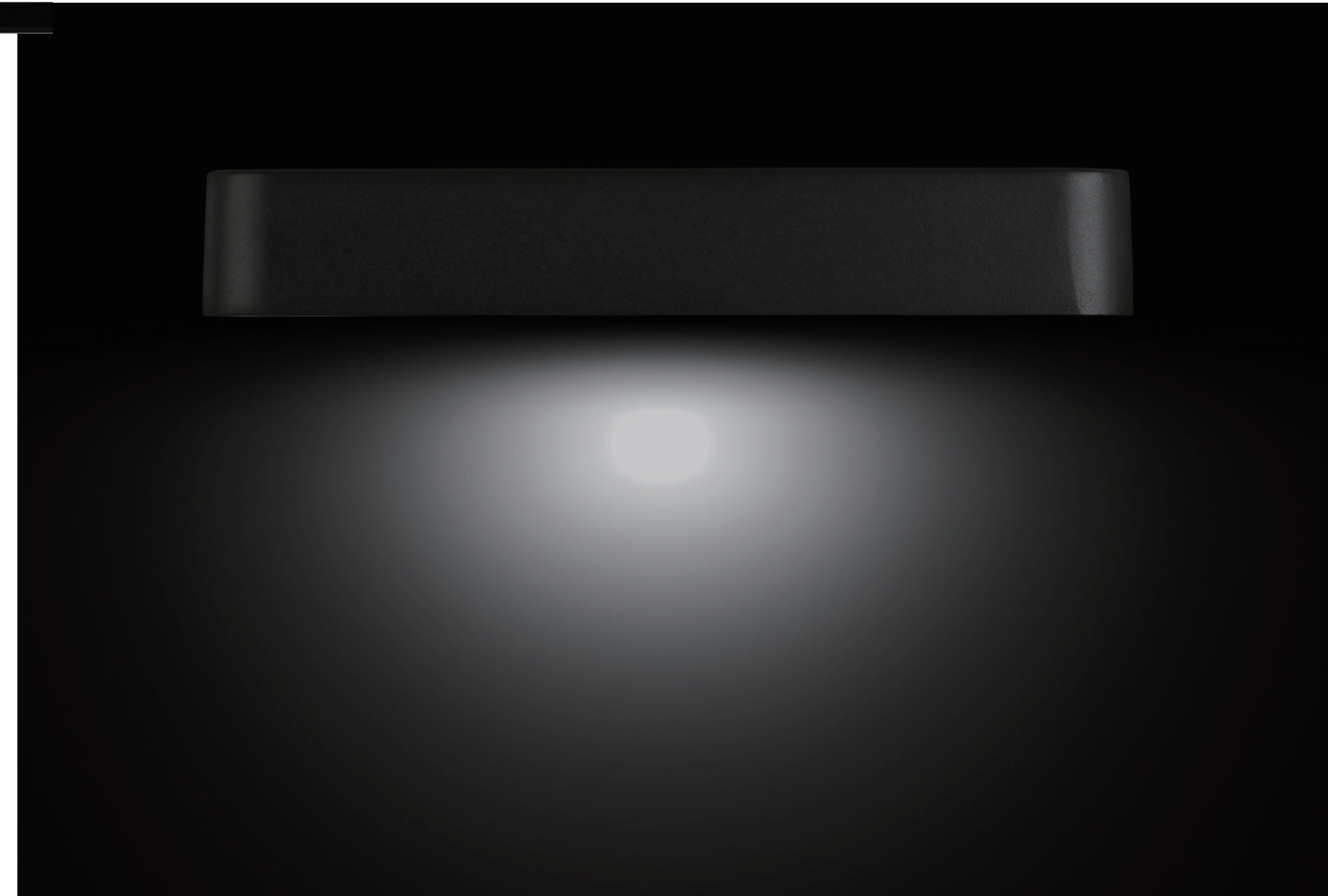
Sometimes it is hard to find the right lighting beam angle for our space when the space are limited somehow. However if the lighting beam angle can be adjustable simple hands which will be the perfect solution in such case. In order to solve this problem, our design invented our ZOOMER lights, you can adjust the beam angle continuity from 5 deg. To 60 deg, which can supply almost any case.

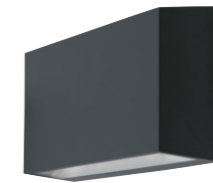

OUTDOOR LIGHTING

WL569 12W  F03WL576 16W  F04WL577 30W  F05WL558 8W  F06

EXTREM NARROW BEAM ANGLE



EXTREM NARROW BEAM ANGLE

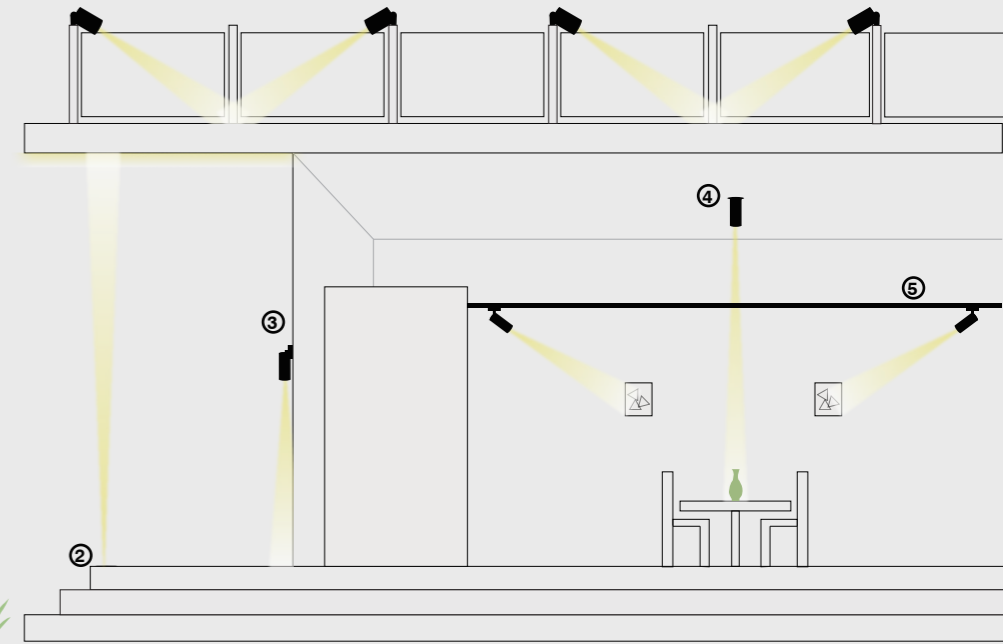

EXTREM NARROW BEAM ANGLE



In some case, we need the lighting aim to a very small target from far distance. Then I think you need our EXTREM NARROW BEAM ANGLE family. They are beam angle from 4 deg. To 7 deg. extremely narrow. This family offer downlights, track lights, even the underground lights which using outside, provide widely selection.





This VERINA family is special design for dining desk or hotel front desk, simple and traditional design outlook, but new cool and touchable LED lighting source instead of hot burning traditional halogen bulbs, make it just like an old friends even closer. Because it is LED lighting source now, so it is more saving energy. Let's replace your old halogen pedant lights to our VERINA ones today; let's save our earth together from now on.

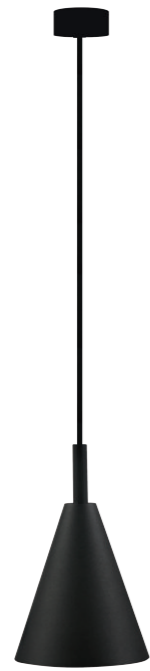

SL372 5W P D13

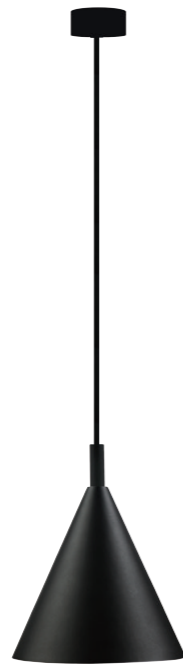

SL373 10W P D13

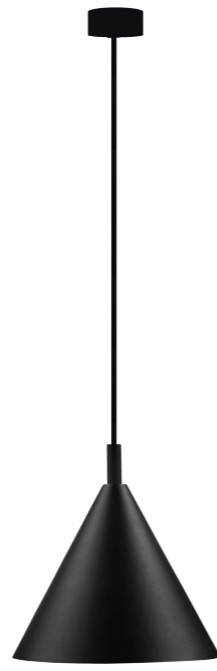

SL374 20W P D13



NEW ARRIVAL

BROWN HAT



BROWN HAT



For the BROWN HAT family, we have 6 different size for people to choose, cover almost all sizes of cutout for halogen downlights.

BROWN HAT

NEW ARRIVAL



KT6979 7W \varnothing 75mm
A07



KT6980 10W \varnothing 95mm
A07



KT6981 12W \varnothing 115mm
A07



KT6982 20W \varnothing 135mm
A07



KT6983 30W \varnothing 150mm
A07



KT6984 40W \varnothing 185mm
A07



No Flicker

Our CUP LED small downlights family are the best economic options for household to replace their transitional MR16 or GU10 downlights. They are 7w, and 770lm including fixed heads and tilted heads. It is enough for most cases.



KT6913 7W A33



KT6914 7W A34



KT6943 7W A37

NEW ARRIVAL

MULTIS SQUARE



Unique design only for unique you

After one year hard job, KETAI design team developed this MULTIS family, it is slim shape, simple look but more function. You can track system them, surface mounted, recessed mounted, pendent or wall surface mounted, we even design one floor version for you.



MHT8846 12W P B09

MHT8846 12W P B09

MHT8846 12W P B09

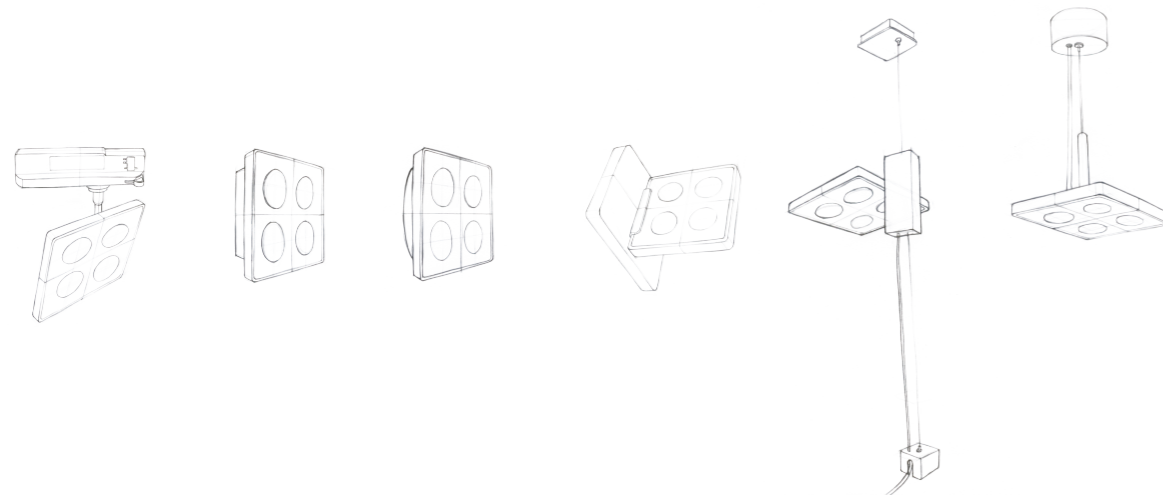

MULTIS SQUARE

NEW ARRIVAL



XD2150 12W P C07

KT7004 12W P A09

SL386 12W P D05



SL388 12W P D08



WL610 12W P E03



NEW ARRIVAL

MULTIS ROUND

MULTIS ROUND

NEW ARRIVAL



Unique design only for unique you

After one year hard job, KETAI design team developed this MULTIS family, it is slim shape, simple look but more function. You can track system them, surface mounted, recessed mounted, pendent or wall surface mounted, we even design one floor version for you.





SEALS

SEALS



The SEALS family is our classic track lights, including 3 steps of power (30w / 40w /60w). For the 30w and 40w track lights we have AC version for you to choice which is without gear box on the top, making the design looks simpler and beautiful. Our designer also figure out some longer arm style based on these family, which is for your unique requirement.



XD2151 8W P_{C12}

IBIS

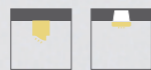
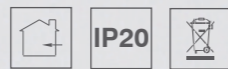

Our IBIS family is magnetic attached LED lights, all the heads attach to their base by strongly magnetic which make the lights head can be adjustable totally free. There are surface mounted downlights, recessed downlights, from single head to 2 heads, easier for people to change the driver or LED chips once they are burned.

KT6915 8W P_{A17}KT6967 8W P_{A11}KT6967-2 2X8W P_{A12}XD2152 2X8W P_{C11}



PIPE

PIPE



Modern LED track lighting with a bold, clean look. Our LED spotlight track brings high-caliber directional lighting system to your interior with advanced LED technology for cost-efficiency and energy saving value. We have driver and without driver AC versions.



MHT8596A 20W **P**B29



MHT8596B 30W **P**B30



MHT8597 40W **P**B31



DRUM

DRUM



The commercial grade LED recessed downlight surface mounted downlights, track lighting system are ideal for retrofitting inefficient fixtures in malls, hospitals, airports offices, lobbies and other commercial applications. Also they are ideal replacements for existing, less efficient incandescent and compact fluorescent (CFL) light sources commonly used in the commercial centers.



MHT8575 47W **P**B28



KT6667 43W **P**A81



KT6679-2 2X43W **P**A86



KT6679-1 43W **P**A85

MINI TRACK LIGHTING



KTK1-8587 7.5W B25



HC-8587 7.5W B25



HKTA-8587 7.5W B25



KTK1-8591 7.5W B26



HC-8591 7.5W B26



HKTA-8591 7.5W B26

MINI TRACK LIGHTING

KTK1-8592 7.5W B27



HC-8592 7.5W B27



HKTA-8592 7.5W B27



MINI TRACK LIGHTING



3 YEARS GUARANTEE

Small LED track lights. This kind of unique design is special for home or shopping mall. Each of the styles we offer has three installation ways: 2 tracking ways or flush surface mounted die cast aluminum construction. Non-dim is standard, dim is optional.

SNAIL



SNAIL

SNAIL bridgelux



3 YEARS GUARANTEE

High power commercial LED lighting series. Anti-glare front ring design can offer more comfortable environment for your clients. Thermo-optional design ensures long lifetime life. Unique original design offers techno- marketing benefits.
 26W systems power
 CRI>80 or 90 on project request
 Beam angle: 18° or 30°



MHT8558 26W
P B22

MHT8554 26W
P B21

MHT8572 26W
P B23



KT6567-2 2X26W
P A52

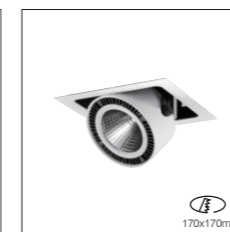

KT6567-1 26W
P A51



KT6566 26W
P A99



XD2022A 26W
P C17



XD2022-L50 26W
P C18

CHANGE MODULE

THIS LED MODULAR DESIGN HELPS OUR CUSTOMER TO REDUCE STOCK LEVEL, SAVING MONEY.



FEATURES

- Unique original design offers KETAI-marketing benefits;
- Quality die-cast construction;
- AC version is available on your project requirement;
- More than 6 styles of frame trimes for your DIY;
- For the LED modular, we offer wide range of beam angles and CCTS, meeting your different application;
- Thermo-optional design ensures long lifetime;
- Our 25 watts LED downlights can provide more than 2600LM bright light.



CITIZEN
KT6583-1 25W
A57

CITIZEN
KT6584-1 25W
A59

CITIZEN
KT6585-1 25W
A61





CITIZEN
KT6583-2 2X25W
A58



CITIZEN
KT6584-2 2X25W
A60

CITIZEN
KT6585-2 2X25W
A62

TURBINE

KT6550 10W   Ø70mm





KT6818 10W   Ø70mm





SMALL EYE



KT6551 10W   Ø70mm



KT6817 10W   Ø70mm

TURBINE



3 YEARS GUARANTEE

- Main material: Aluminum
- Surface finish: white, grey, black
- Thermally engineered heatsink is robust and offers cooler operation
- High grade diffuser provides uniform light as well as greatly illuminates environment
- Anit-glare reflector creates visual comfort
- Easy to install with two spring clips
- Easy to replace MR16 or GU10 halogen small spotlights
- Beam angle: 30° / 60°
- Non-dim is standard, dim is optional.

SMALL EYE





- Thermally engineered heatsink is robust and offers cooler operation
- High grade diffuser provides uniform light as well as greatly illuminates environment
- Anit-glare reflector creates visual comfort
- Easy to install with two spring clips
- Easy to replace MR16 or GU10 halogen small spotlight

TWINS





bridgelux. TILTED HEAD

Model	Watt	Cutout	Page
KT6821	11W	 Ø81x81mm	P A45
KT6822	11W	 Ø81mm	P A46



bridgelux. FIXED HEAD



Model	Watt	Cutout	Page
KT6564	11W	 78x78mm	P A49
KT6565	11W	 Ø78mm	P A50



Thermally engineered heatsink is robust and offers cooler operation high grade diffuser provides uniform light as well as greatly illuminates environment.
Anti-glare reflector creates visual comfort
Easy to install with two spring clips
Easy to replace MR16 or GU10 halogen small spotlights.



 NICHIA DIFFUSER COVER

Model	Watt	Cutout	Page
KT6564A	11W	 78x78mm	P A47
KT6565A	11W	 Ø78mm	P A48

COUPLE



3 YEARS GUARANTEE

Surface finish: white, grey, black
Thermally engineered heatsink is robust and offers cooler operation
High grade diffuser provides uniform light as well as greatly illuminates environment
Anti-glare reflector creates visual comfort
Easy to install with two spring clips

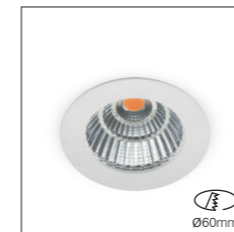

KT6598 7.5W [P A73](#)

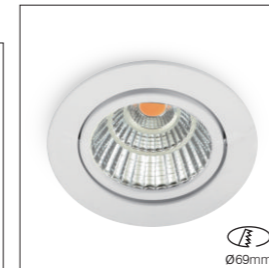

KT6599 7.5W [P A74](#)



KT6613 7.5W [P A71](#)



KT6614 7.5W [P A72](#)

CLOWN FISH

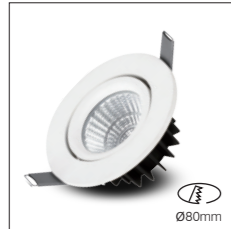

KT6595 7.5W
A36



Front ring changable KT6595



KT6814-1 7.5W
A39



KT6814-2 2x7.5W
A40



KT6560-1 7.5W
A43



KT6560-2 2x7.5W
A44

CLOWN FISH



3 YEARS GUARANTEE

Surface finish: white, grey, black
 Thermally engineered heatsink is robust and offers cooler operation
 High grade diffuser provides uniform light as well as greatly illuminates environment
 Anti-glare reflector creates visual comfort
 Easy to install with two spring clips
 Easy to replace MR16 or GU10 halogen small spotlights
 Non-dim is standard, dim is optional.

NASSARIUS

NASSARIUS bridgelux



3 YEARS GUARANTEE

Surface finish: white, grey, black
 Thermally engineered heatsink is robust and offers cooler operation
 High grade diffuser provides uniform light as well as greatly illuminates environment
 Anti-glare reflector creates visual comfort
 Easy to install with two spring clips



KT6554 7.5W A31



KT6662 7.5W A32



CANNON

CLAMP

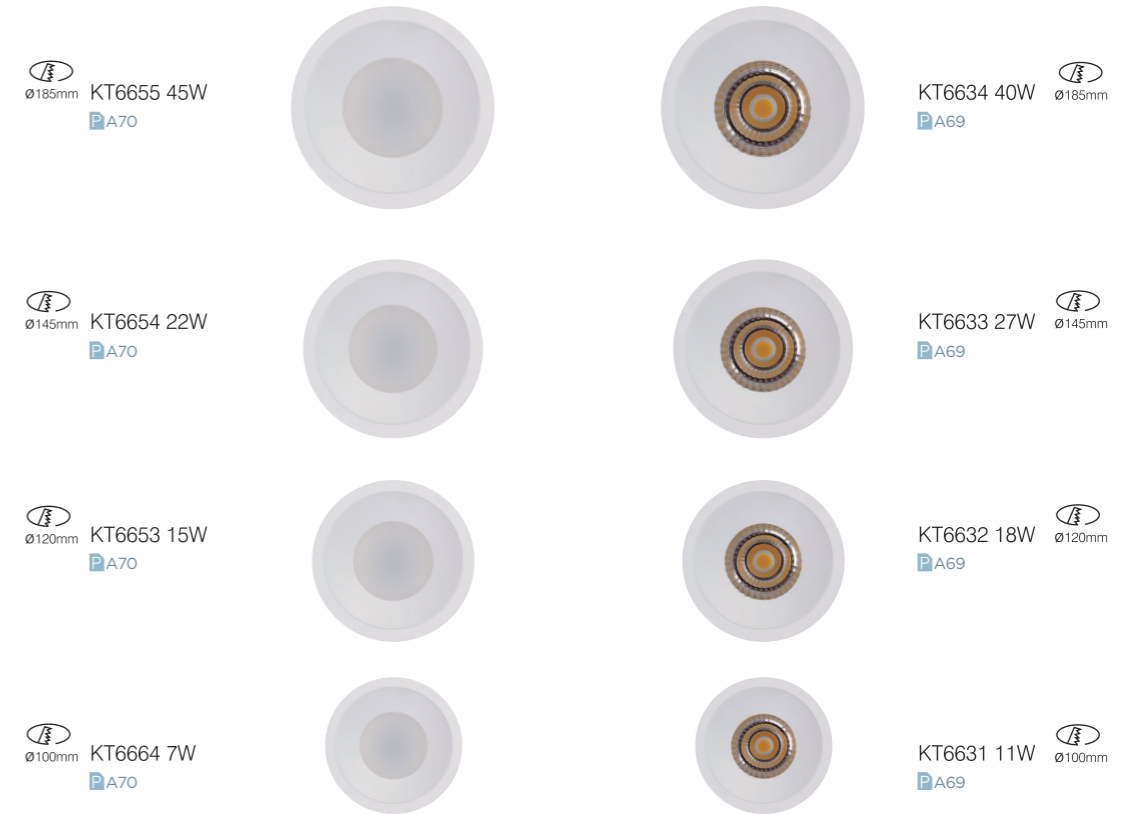

CANNON



MAX SYSTEM POWER 16W OUTPUT 1200LM

A complete family of downlights featuring fixed round or square, gimbaled round designs available in white, grey, black power coating and custom finishes. They boast higher efficiency, virtually do not require any maintenance and ultimately have a lower cost than standard halogen lights.

KATAI qualified and simple designed architectural downlight fixtures are offered in 4", 5", 5.5" and 8" aperture sizes, along with different wattages and luminous output work with a wide variety of ceiling systems.



SARDINE (Recessed)



KT6636 11W
P A38



KT6647-1 11W
P A29



KT6647-2 2X11W
P A30



KT6648-1 11W
P A27



KT6648-2 2X11W
P A28



KT6659-1 11W
P A25



KT6659-2 2X11W
P A26

SARDINE (Surface mounted)



Model NO	Power (W)	Page
XD2036-1	11	P C21
XD2036-2	2X11	P C22

SARDINE *bridgelux*



3 YEARS GUARANTEE

Thermally engineered heatsink is robust and offers cooler operation
High grade diffuser provides uniform light as well as greatly illuminates environment

Anti-glare reflector creates visual comfort

Easy to install with two spring clips

Easy to replace MR16 or GU10 halogen small spotlights

Non-dim is standard, dim is optional.

RETROFIT DOWNLIGHTS



KT6596A 11W P A24



KT6594A 11W P A23

P65 11W waterproof LED downlights use in wet rooms, showers and bathrooms. They are adjustable recessed LED downlight with symmetrical light distribution on a medium beam and with high degree protection. KETAI enhances every the aesthetics of details or architectural elements.



KT6594 11W P A21



KT6596 11W P A22

FLOUNDER



KT16-3 3X8W 3xØ75mm P A87

KT16-2 2X8W 2xØ75mm P A87

KT16-1 8W Ø75mm P A87

FLOUNDER



New ceiling light fixtures are a wonderful way to add fresh style to your home . They come in many different shapes and sizes. You will find a beautiful, energy-efficient choices for replacing an existing ceiling light, available in a wide variety of styles and finishes. These exquisite flush mounted designs are ideal for dressing up any space at your home!

TRUE LED FIRE RATED DOWNLIGHTS

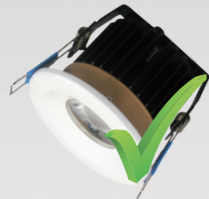

Integrated fittings guarantee quality

- ✓ Fire protection you can trust
- ✓ Guarantee performance
- ✓ Unique design ensures airflow
- ✓ 3 year extended warranty



Replacement LED lamps compromise safety & reliability

- ✗ No guarantee of fire safety
- ✗ Not designed to operate with a can
- ✗ Heat build up reduces LED life
- ✗ May void warranty



KT6830 8W Φ 70MM
A98



BOWL



KT6826 16W Φ 165mm
A35

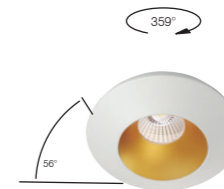

KT6827 16W Φ 100mm
A98



XD2077-1 16W
C31



XD2077-2 16W
C32

BOWL



Perfectly combines design and function. Optimized passive cooling system ensures low temperature and long lifetime of Red. Front ring provides good glare control, white black is standard. All black or white are optional. A combination of perfectly developed lenses and reflector provides high precision light distribution. For the track lights adapter: 3-phase is standard, 1-phase adapter is available upon request.

UFO



KT6347B 20W A64



KT6347 11W A63

UFO



Honeycomb mesh back over design for excellent heat release
 Aluminum die-casting material
 Correlated color temperature 3000K standard, 4000K optional

CONCH



Mini LED downlights accentuate the finish and mitring details of these cabinet faces. KETAI Mini LED Recessed Downlights and Gimbals are the perfect solution for a task or lighting accenin confined spaces. As little as 6.4cm in diameter. These tiny second generation LED fixtures truly fit in the palm of your hand.

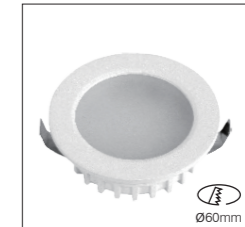

FT210 3W A75



FT210C 3W A75

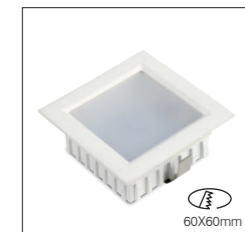

FT211 3W A76



FT211C 3W A76

SQUARE



KT6808A 12W
A77

KT6808B 16W
A78

KT6808C 16W
A79



KT6355A 20W
A67

KT6355 12W
A68

SQUARE



Square - sharp recessed and surface mounted LED downlights. Thermally engineered heatsink is robust and offers cooler operation adjustable up to 85 degrees. Die-cast aluminum construction. Non-dim is standard, dim is optional. 3 years guarantee

EYEBALL



KT6815 8W
A88

KT6816-1 8W
A89

KT6816-1 2X8W
A90

MHT8588 8W
B24

EYEBALL



These eyeball style LED lights perfectly combine design and function. They offer three installation ways: tracking or flush surface mounted and recessed die cast aluminum construction. Non-dim is standard, dim is optional. 3 years guarantee

LED LINEAR



LED LINEAR

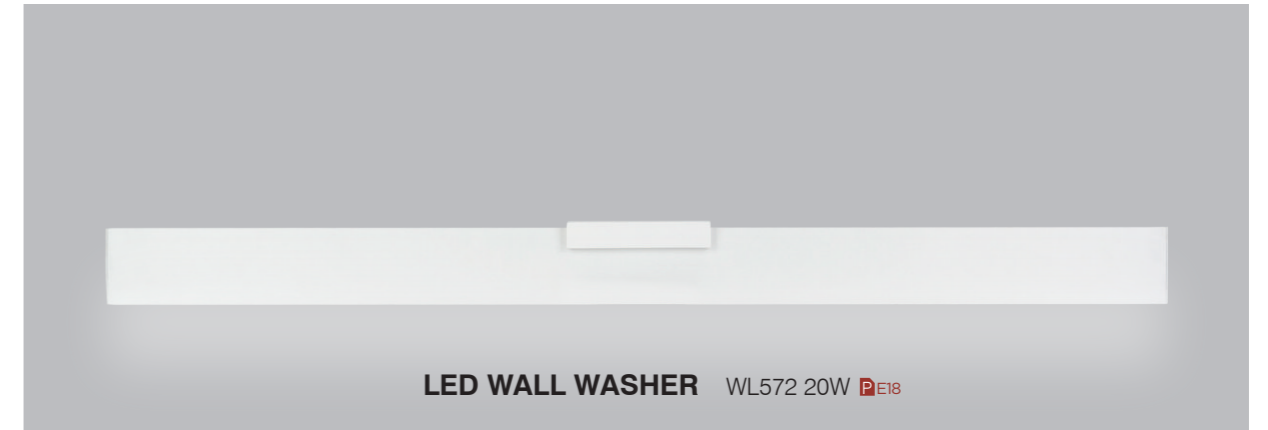

LED WALL WASHER WL572 20W P E18

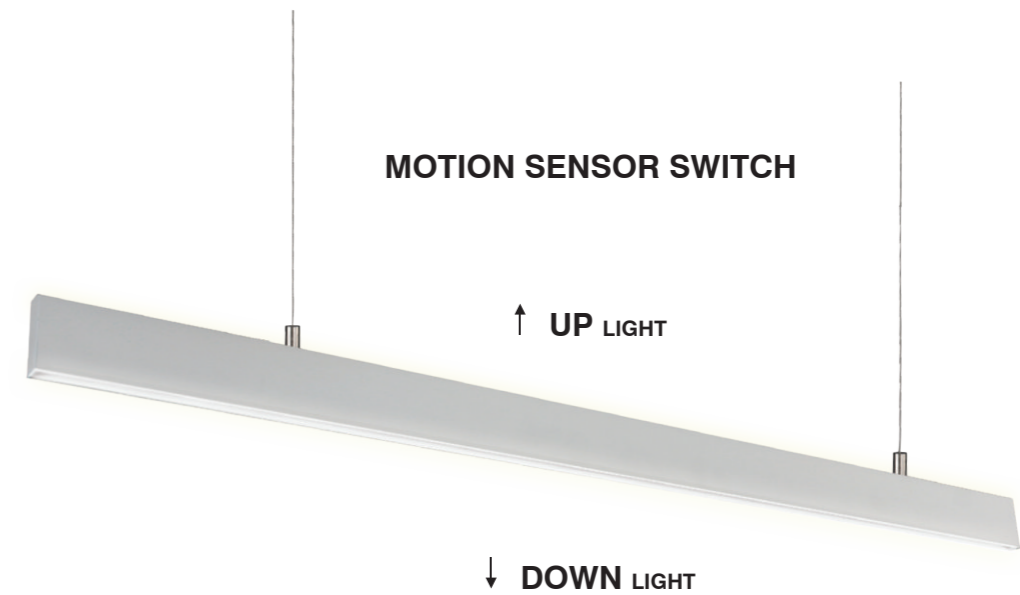

MOTION SENSOR SWITCH

↑ UP LIGHT

↓ DOWN LIGHT

KF1027 37W P 1040XH75MM P D26

KF1027A 37W P 1040XH56MM P D26

LED LINEAR



New ceiling light fixtures are a wonderful way to add fresh style to your home. They come in many different shapes and sizes. You will find beautiful, energy-efficient choices for replacing and existing ceiling light, available in a wide variety of styles and finishes. These exquisite flush mounted designs are ideal for dressing up any space in your home

SQUARE PANEL

SQUARE PANEL

COMBINATION OF DESIGN AND FUNCTION

KETAI LED PANEL LIGHT

It is unmistakably part of the family from the very glance. The panel light perfectly complements the floor lights in the series and promises a harmonious overall design for lighting planning in all offices. This panel lights is just as time-lessly sleek and elegant in appearance, featuring high - quality materials and excellent light quality. Every detail is designed to impress: to preserve the clean-cut, aesthetic design, the cable routing is invisibly hidden in the suspension.



XD2017 24W **P**C29



XD2018 18W **P**C30



KF1014 35W **D**D25

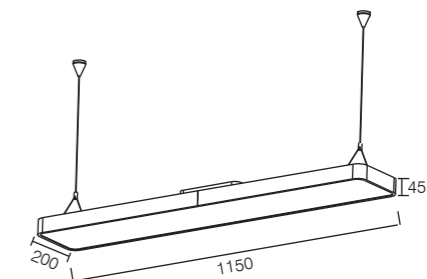

ELEPHANT NOSE



KT6883 10W A94



KT6884 20W A95



KT6885 40W A96

ELEPHANT NOSE



Perfectly combines design and function. Optimized passive cooling system ensures low temperature and long lifetime of LED. Front ring provides good glare control, white black is standard. All black or white are optional. A combination of perfectly developed lens and reflector provides high precision light distribution. For the track lights adapter: 3-phase is standard, 1-phase adapter is available upon request.

MINI PIPE



SL367 3W D15



SL368 3W D16



SL369 3W D14



MINI PIPE



PENDANTS

Every room needs light in order to be truly complete. KETAI provides far more than a simple functional for a hotel in the evening; It creates the essence of a space's ambience and enhances it, making each room come alive. Our pendants feature diverse shapes that combine well with a room's personality, from pipe round to square. Many are available in the groups of three of three or more heights, meaning that creating clusters of descending pendant is easy.

PANEL AND DOWN LIGHTS

JELLYFISH

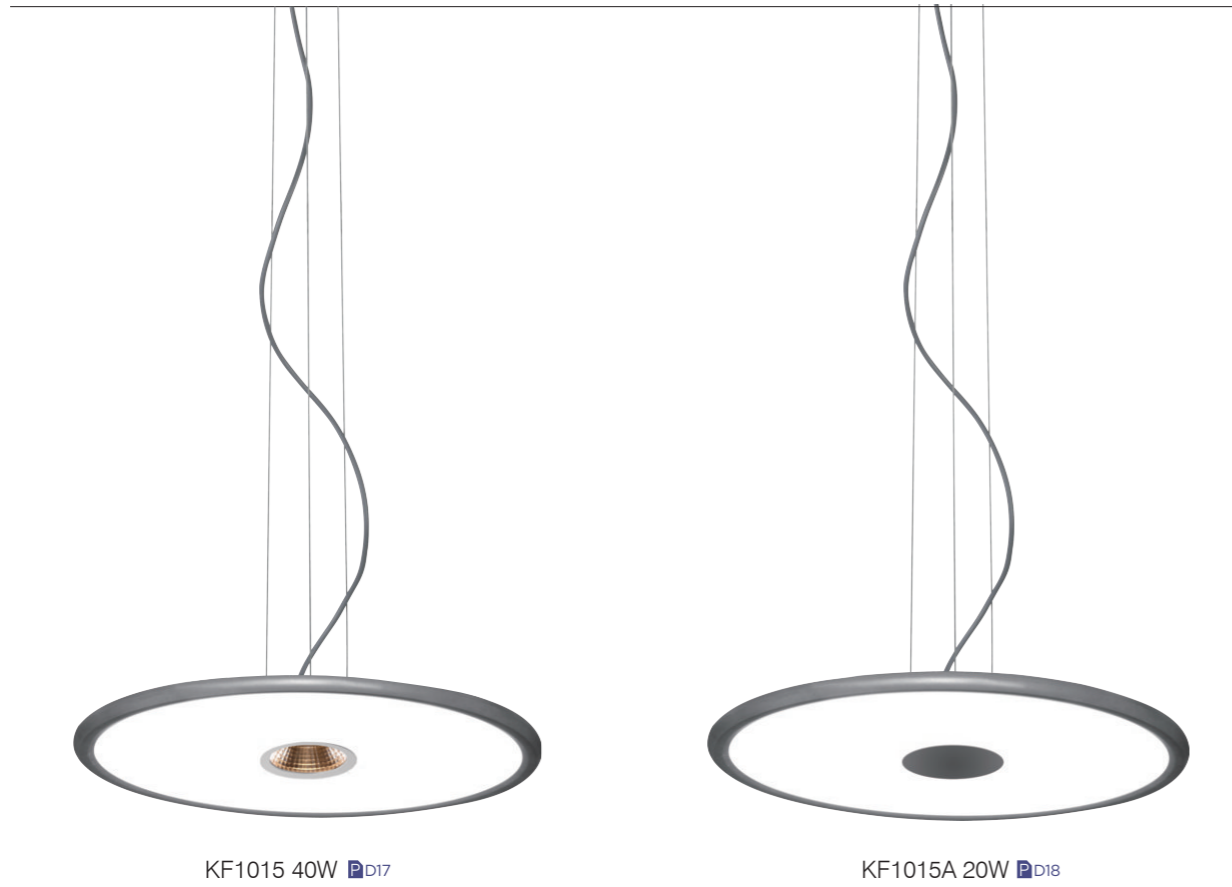

JELLYFISH



Suspended from the center of room, flush mount lighting fixtures are ideal for providing general overall illumination. Flush mount or suspended fixtures are perfect to use in bedrooms, bath areas and kitchen spaces. These fixtures are easy to install and prove a fresh decorative touch for home diy renovation projects.

- KF1031 Ø368 25W AC PD20
- KF1030 Ø417 30W AC PD20
- Golden Red Black

PANEL AND DOWN LIGHTS



A big size single pendant can add a more unique aspect to your personal spaces. You choice of lighting has the power to creative tones of sophistication and elegant cool professionalism, warmth or trendy style depending on your personal design vision. We specialized in supplying quality pieces that highlight its natural decor and creative rooms that are visually impressive and make your clients feel relaxed and happy.



- XD2097 Ø368 25W AC PC24
- XD2096 Ø417 30W AC PC24

FISH EYES



XD2080 Φ 222mm 16W **P**C23



XD2079 Φ 182mm 11W **P**C23



XD2078 Φ 124mm 8W **P**C23

FISH EYES



Suspended from the center of a room, flush mount lighting fixtures are ideal for providing general, overall illumination. These fixtures are perfect for use in bedrooms, bath areas and kitchen spaces. These fixtures are easy to install and provide a fresh decorative touch for home diy renovation projects.

MOBULA



KF1019 20W Φ 368 **P**D19

KF1020 30W Φ 500 **P**D19

KF1021 50W Φ 750 **P**D19

KF1022 100W Φ 1000 **P**D19

MOBULA



A big size single pendant can add amore unique aspect to your personal spaces. Your choice of lighthing has the power to create tones of sophistication and elegance cool professionalism, warmth or trendy style depending on your personal design vision. We specialize in supplying quality pieces that highlight its natural decor and create rooms that are visually impressive and make your clients feel relaxed and happy.

XD2059 22W Φ 405 **P**C19

XD2060 34W Φ 505 **P**C19

XD2061 40W Φ 605 **P**C19



DOLPHINS

SL363C 40W 

SL363B 28W 

SL363A 20W 

SL362C 40W 

SL362B 28W 

SL362A 20W 

DOLPHINS



PENDANTS

Every room needs light in order to be truly complete. KETAI provides far more than a simple functional for a hotel in the evening; It creates the essence of a space's ambience and enhances it, making each room come alive. Our pendants feature diverse shapes that combine well with a room's personality, from pipe round to square. Many are available in the groups of three or more heights, meaning that creating clusters of descending pendants is easy.

CUTTLEFISH

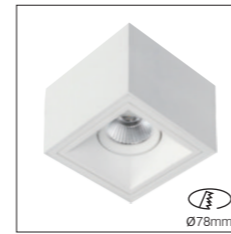

KT6578 11W 

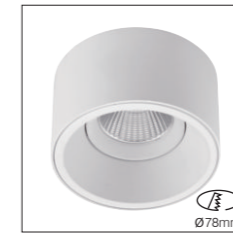

KT6577 11W 



XD2019 11W 



XD2020 11W 

CUTTLEFISH



Closed-to-ceiling lights naturally draw the eye upward and highlight higher up elements in a space, like crown molding or unique architecture. These low profile light fixtures are comprised of perfectly flush mounted lighting and semi-flush mounted fixtures. Flush mount and semi-flush mount ceiling lights provide overall illumination when a larger wash is needed versus focused spotlight and they are the ideal lighting option when your ceiling to floor height is limited. This selection of close-to-ceiling lighting can become sculptures in and of themselves too, providing a functional and fashionable role in modern spaces.

BALLOONFISH

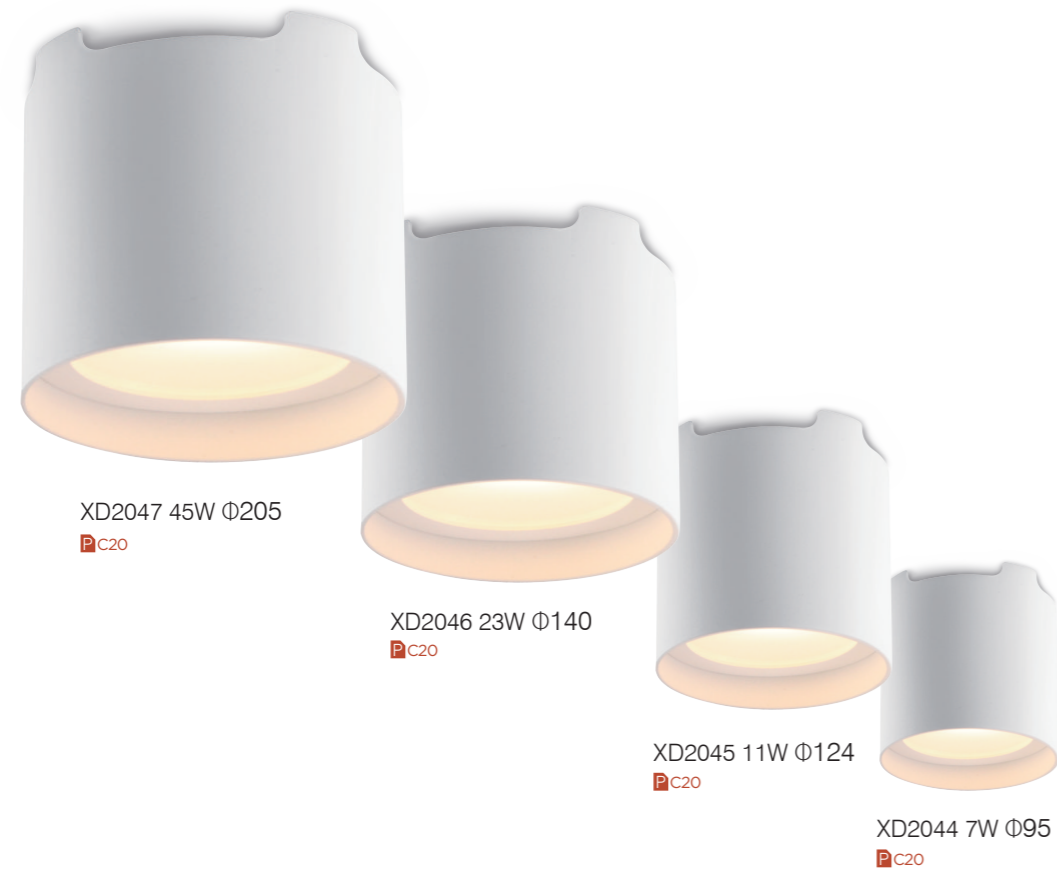

DOLPHINS



These surface mounted LED lights are specially designed with a simple, elegant style to compliment and home interior which features a classic simple white finish adding warm and welcomeing diffused light. The durable aluminum construction ensures that this ceiling light will continue to perform well. With a striking apperance for years to come. Solid aluminum construction offers lasting durability. Easy to install with included hardware. Simple, classic style works well with any decor.

OWL

Surface mounted



XD2055A 32W P C15



XD2055B 32W P C16

Wall mounted



WL545A 32W P E19



WL545B 32W P E20

OWL



System power 32W
Aluminum die-casting material has 2 ways of installation
Narrow beam angle 24°
Wide beam angle 100°

TWIST

TWIST

Combines classic cylindrical shape design with effective heat management these cylindrical lighting fixtures are perfect for MR16 or GU10 LED bulbs die cast aluminum construction.

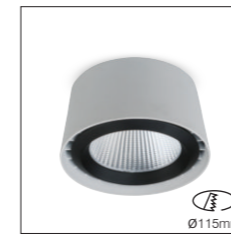

CONE



KETAI is one of the most respected names in architectural downlighting, with a specific focus on architectural integration, optical performance, reliability and innovative manufacturing processes. Our innovative products feature LED lighting sources